

**faraone**<sup>®</sup>

PARAPETTI

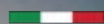

I PARAPETTI IN VETRO N.1 IN ITALIA

SPETTATORI E GIOCATORI AL CENTRO

# VISIBILITA' E SICUREZZA IN TRIBUNA, CON NINFA 6 STADIO

Roberto Volpe – CMO | Matteo Paolini – Direttore Tecnico

**faraone**<sup>®</sup>



soci



ASSOCIAZIONE  
IMPIANTI  
SPORTIVI

faraone.it

# ROBERTO VOLPE

# *faraone*<sup>®</sup>

PARAPETTI



I PARAPETTI IN VETRO N.1 IN ITALIA

**> + 2.000 CHILOMETRI DI PARAPETTI  
INSTALLATI DAL 2009 AD OGGI**

**> 100 PARTNER IN TUTTA ITALIA**

**> 1 SU 4 PARAPETTI SONO DI FARAONE\***

**\*Ricerca di Mercato: Smartland**

# *faraone*<sup>®</sup>

PER LO SPORT



**FARAONE PROPONE  
PARAPETTI IN VETRO  
CERTIFICATI DALLE ALTE  
PERFORMANCE (NO  
BARRIERE VISIVE):  
STADI, PALAZZETTI,  
PISCINE, CENTRI SPORTIVI**



# Usereste un casco da bici in MotoGP?

È pur sempre un casco.

**NO**  
A BARRIERE VISIVE



**SI**  
A TRIBUNE SICURE

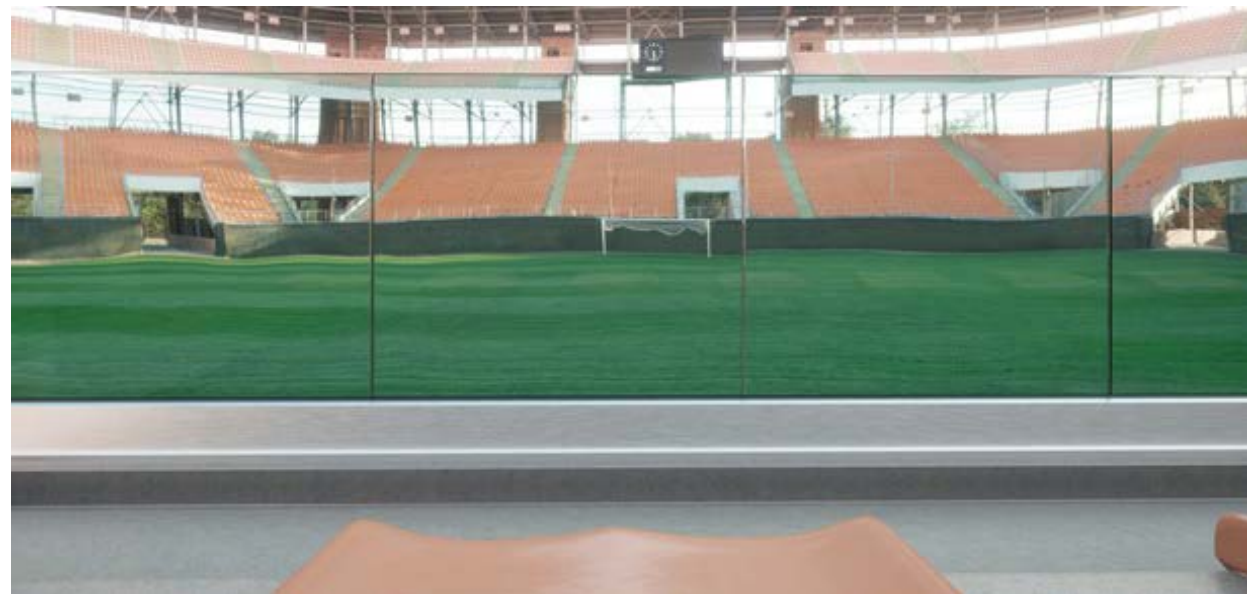

## Accenni di sicurezza nelle tribune

si

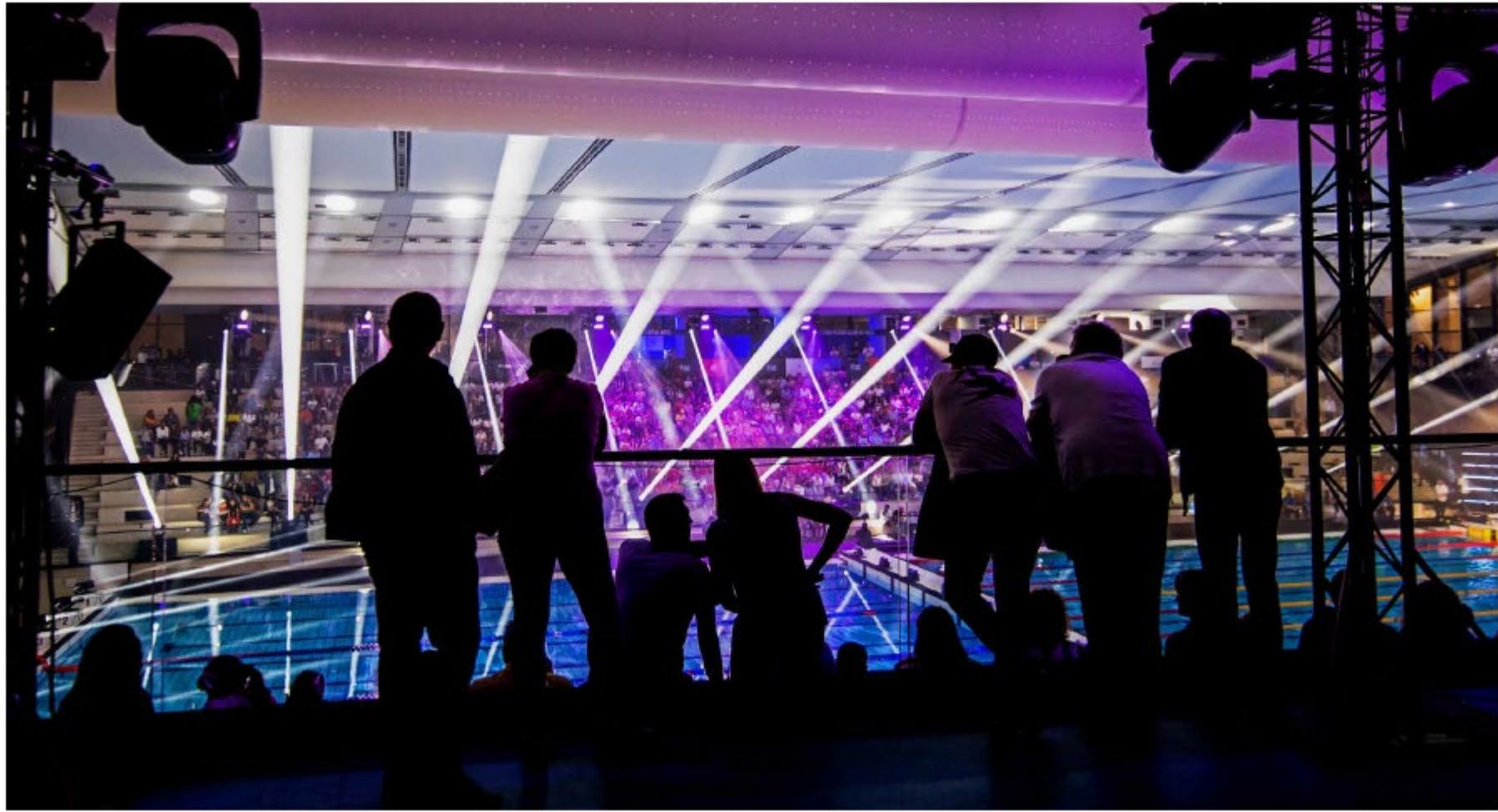

# Gli Stadi più Vecchi d'Italia



**Luigi Ferraris  
(Genova) - 1911**



**Pier Luigi Penzo  
(Venezia) - 1913**



**Arena Garibaldi  
(Pisa) - 1919**



**Ennio Tardini  
(Parma) - 1924**



**San Siro  
(Milano) - 1926**



**Dall'Ara  
(Bologna) - 1927**

# QUANTE TRIBUNE SONO AGGIORNATE ALLE NORMATIVE VIGENTI?



Dal punto di vista anagrafico, la vetustà degli impianti rappresenta invece una criticità diffusa sull'intero territorio nazionale. Come già emerso, lo sviluppo dell'impiantistica sportiva in Italia è storicamente legato ai grandi eventi sportivi: oltre il **40% degli impianti** risulta infatti essere stato realizzato negli anni Settanta e Ottanta, con un picco di costruzioni nel periodo **1980-1989** in quasi tutte le regioni<sup>17</sup>.

Rispetto al **2%** degli impianti costruiti a partire dal 2020, l'**80% è inoltre costituito da playground**.

Va inoltre considerato che numerosi interventi sono attualmente in fase di realizzazione e confluiranno nelle statistiche una volta completati.

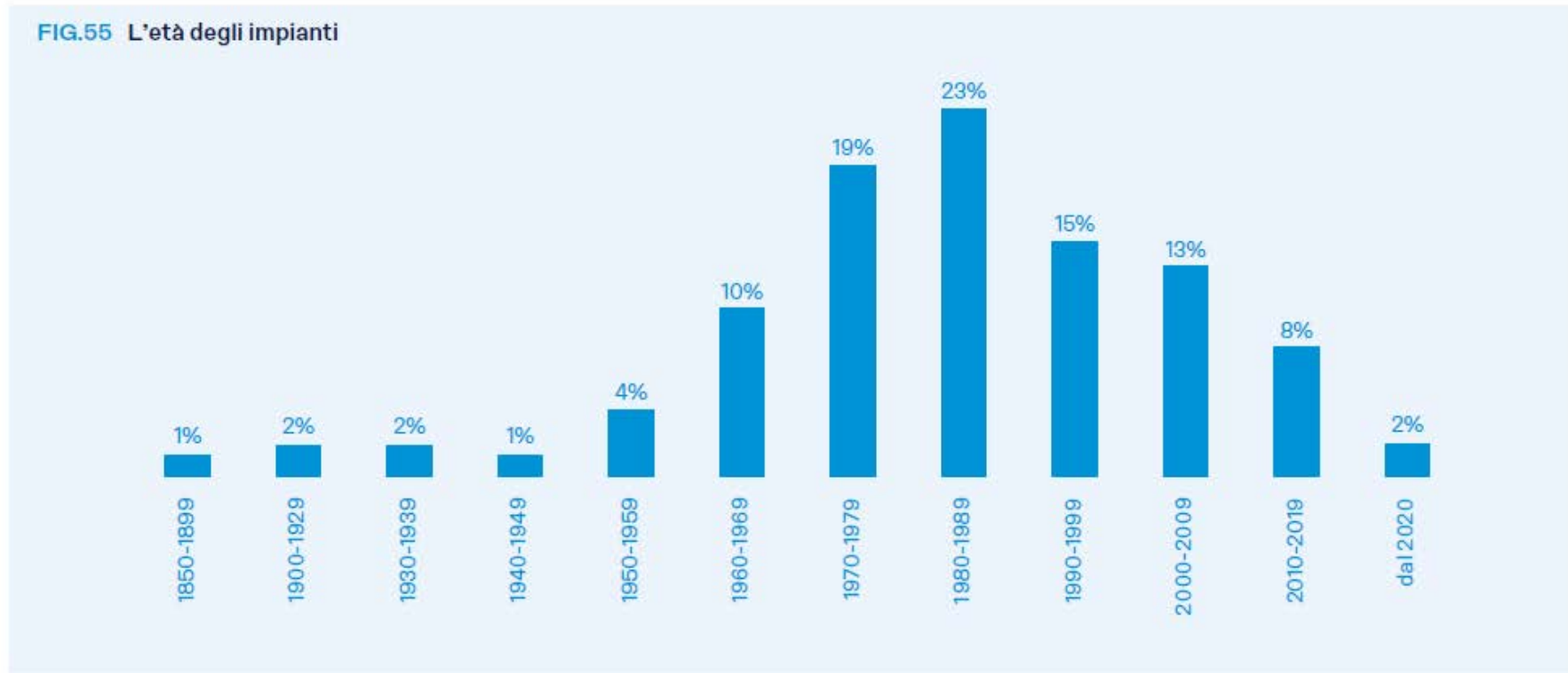

Fonte: Censimento Nazionale Impianti Sportivi, novembre 2025.

Dal Rapporto Sport & Salute del 2025





- Più del **79%** degli impianti sportivi italiani potrebbe presentare **criticità legate alla sicurezza dei parapetti e visibilità** perché costruiti in data antecedente al 2000.
- Il **90%** è da **verificare** perché ante 2009.
- Il restante **10%** da verificare.  
**Nuovo ≠ A norma**

- Molte tribune datate (parapetti pre-UNI 11678:2017) oggi non sono “dimostrabili”: mancano spesso prove di sistema e verifiche aggiornate su ancoraggi/supporti, proprio dove c’è pubblico.
- Le norme esistono (es. **UNI EN 13200**), ma sono spesso ignorate o sottovalutate.
- E quando succede qualcosa, il responsabile non è “qualcun altro”.

**LE TRIBUNE DEVONO ESSERE RIPROGETTATE BENE**





# Usereste un casco da bici in MotoGP?

È pur sempre un casco.

## ERRORI COMUNI

- In una tribuna, improvvisare è già un errore
- Pensare al parapetto come un dettaglio finale
- Pensare solo alla protezione e non alla visone (o viceversa)
- Pensare che il parapetto nuovo è sinonimo di sicurezza (schede)
- Pensare che tutti i parapetti sono uguali
- Progettare il nodo, senza considerare tutti gli elementi e senza prevedere il comportamento specifico (supporto, fissaggio, sistema)

## **I PARAPETTI PER TRIBUNE: SICURI, TRASPARENTI, DURATURI, SPECIFICI PER OGNI ZONA**

- Pacchetto tecnologico adeguato (profilo, vetro, fissaggio, struttura)
  - Testa di spinta e di impatto reali
  - Vetri di sicurezza alti fino a 3 m per dividere le tifoserie e garantire la visione
  - Finiture personalizzabili, modulari, resistenti nel tempo
-

- Parapetti in vetro secondo norme vigenti (es. UNI EN 13200 > Ing. Romagnoli)
- Sistemi compatibili con impianti nuovi o esistenti da adeguare
- Design integrabile in qualsiasi contesto sportivo
- Garantire una buona curva di visibilità
- Maggior valore architettonico
- DWG, BIM, PDF specifici

**LA SICUREZZA E L'ESPERIENZA DI SPETTATORI E GIOCATORI AL CENTRO**



# Usereste un casco da bici in MotoGP?

È pur sempre un casco.

Storyteller #10

STORIE DI PROGETTI D'ECCELLENZA

# Derthona

*Parapetti in vetro Faraone per la Cittadella dello Sport "Marcellino e Pietro Gavio"*

General Contractor: CODELFA S.p.A.



**faraone**

faraone.it | barrecaelavarra.it

barreca & la varra

**faraone**<sup>®</sup>



soci



ASSOCIAZIONE  
IMPIANTI  
SPORTIVI

faraone.it



ASSOCIAZIONE  
IMPIANTI  
SPORTIVI



**FARAONE INSIEME AD AIS PER PROMUOVERE LA  
CULTURA DI UNA BUONA PROGETTAZIONE E LA  
CORRETTA POSA IN OPERA NEGLI IMPIANTI  
SPORTIVI**

**GRAZIE.**

**FARAONE@FARAONE.IT**

ROBERTO VOLPE | MATTEO PAOLINI | GABRIELE ROMAGNOLI | WILLIAM BARNI

---

**faraone**<sup>®</sup>

PARAPETTI

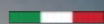

I PARAPETTI IN VETRO N.1 IN ITALIA

SPETTATORI E GIOCATORI AL CENTRO

**VISIBILITA' E SICUREZZA**

**IN TRIBUNA, CON NINFA 6 STADIO**

Roberto Volpe – CMO | Matteo Paolini – Direttore Tecnico | Gabriele Romagnoli – Ingegnere

**faraone**<sup>®</sup>



soci



ASSOCIAZIONE  
IMPIANTI  
SPORTIVI

faraone.it

# MATTEO PAOLINI



# **NINFA**<sup>®</sup> **6 STADIO**

**IL PARAPETTO IN VETRO SICURO IDEATO PER IMPIANTI SPORTIVI**

# L'eccellenza del sistema Ninfa 6 Stadio al vertice della sicurezza e dell'innovazione Faraone

# NINFA 6 STADIO

IL PARAPETTO IN VETRO SICURO IDEATO PER IMPIANTI SPORTIVI

Lo sport è divertimento allo stato puro. Negli stadi e nei centri sportivi si va per ammirare i campioni e questa balaustra è all'altezza delle più grandi performance sportive.

Massima sicurezza per luoghi di grande affollamento.

Optional: Led pack esterno e corrimano.

Finiture: Personalizzazioni di serie e a richiesta.

## NINFA 6 STADIO P



Per ambienti molto affollati:

- Impianti sportivi
- Divisori
- Barriere
- Vetri di grandi altezze

1° PRESTAZIONI INIMITABILI

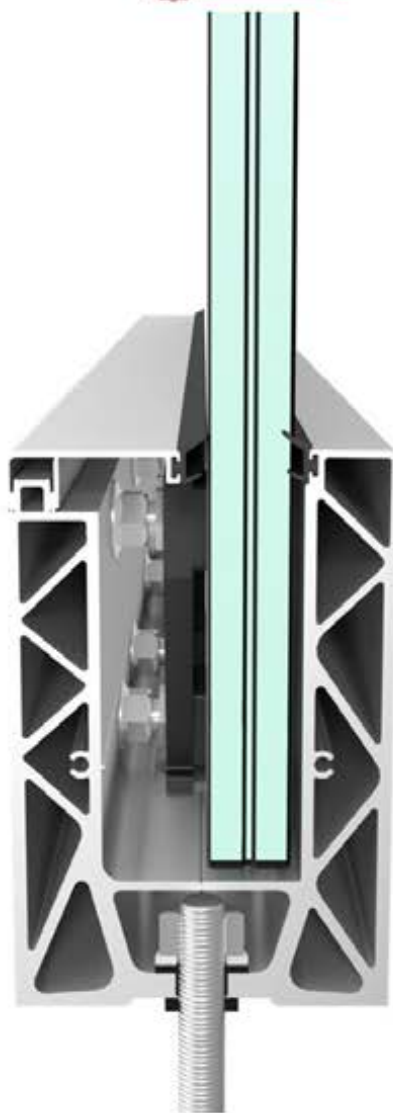

# NINFA<sup>®</sup> STADIO



# NINFA<sup>®</sup> 6 STADIO

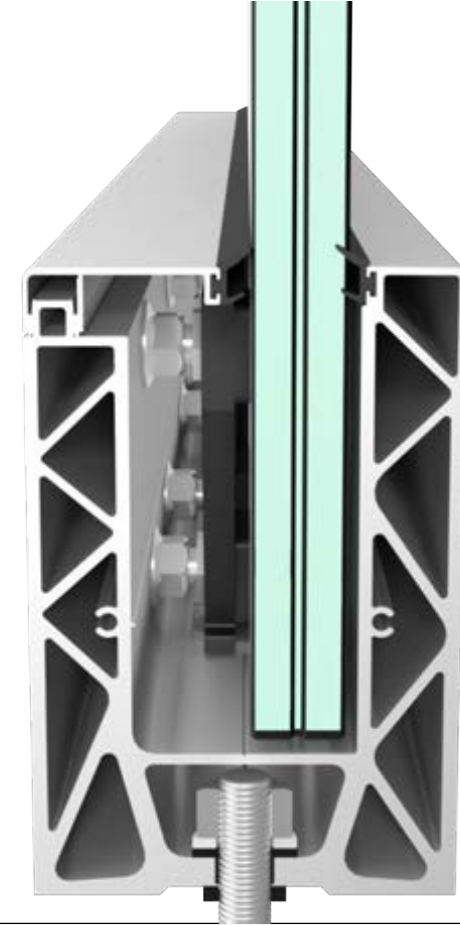



Cittadella

Cittadella dello Sport di Tortona

# DISEGNI TECNICI

In questa scheda viene mostrato l'elenco completo dei componenti principali.

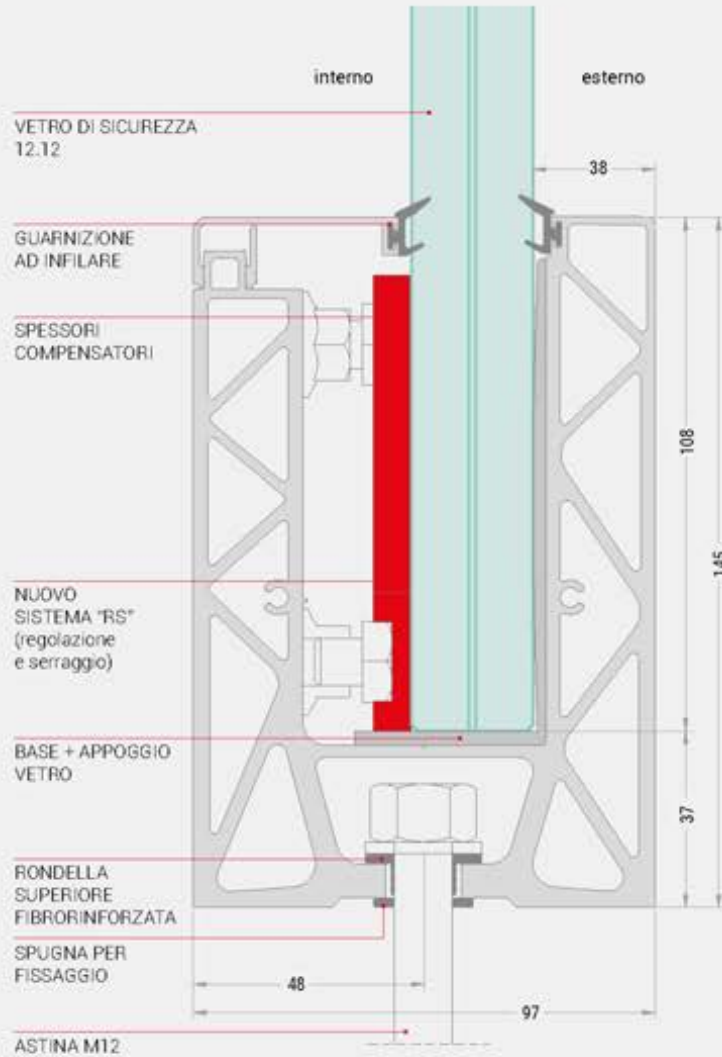

**SPESSORE VETRO:**  
Lo spessore del vetro è 12.12

ASSEMBLAGGIO REGISTRI "RS" - VETRO 10+10

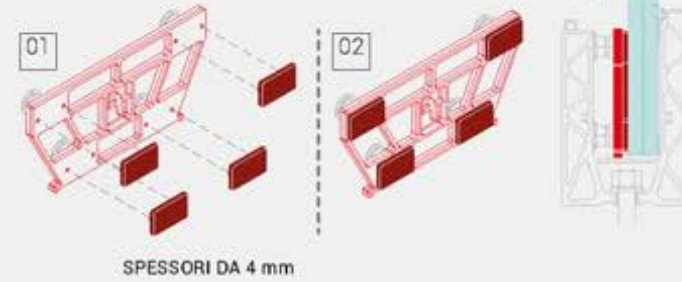

ASSEMBLAGGIO REGISTRI "RS" - VETRO 12+12



**PRINCIPALI APPLICAZIONI**

SOPRA PAVIMENTO

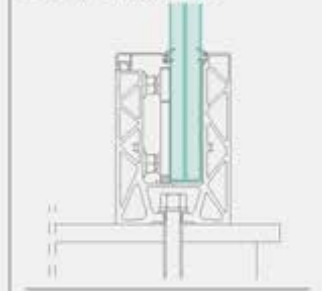

# Verticalità oltre i Limiti

## Altezze fino a 3 Metri

- **Barriera Trasparente**

Il primo parapetto in vetro che agisce come una vera parete protettiva trasparente.

- **Stabilità Evoluta**

Il profilo in alluminio, lavorando in sinergia con registri dedicati, garantisce alte performance anche a quote record.

- **Il Vantaggio**

Massimizzare la protezione senza sacrificare un centimetro di panorama.



Per altezze di 3 metri si consiglia l'utilizzo di un corrimano.

# LA SICUREZZA SIMMETRICA

## Affidabilità Bidirezionale e Efficienza di Posa



### Resistenza simmetrica

Progettato per resistere a carichi di spinta estremi in modo perfettamente simmetrico, garantendo sicurezza indipendentemente dalla direzione della spinta.



### Regolazione Brevettata

Allineamento e pendenza si correggono esclusivamente dal lato interno, semplificando notevolmente la posa e la manutenzione.

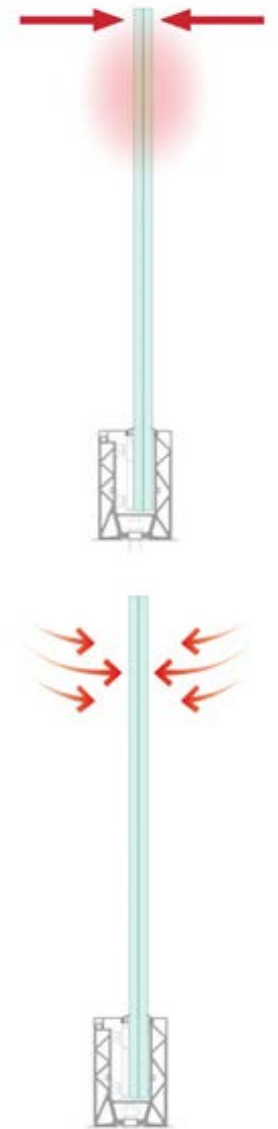

# DETTAGLI CHE CONTANO NINFA LA SERIE 6

# Ogni dettaglio è curato per durare.

- **Boccola di fissaggio:** l'utilizzo di una boccola dedicata serve a creare uno schermo fisico tra l'astina in acciaio e il profilo in alluminio della balaustra. Questo accorgimento previene il contatto diretto tra metalli diversi, un fattore critico per evitare la corrosione galvanica, che potrebbe compromettere l'integrità strutturale nel tempo.
- **Guarnizione adesiva:** la guarnizione applicata sotto il profilo in alluminio ha la funzione di schermare ulteriormente la porzione inferiore dell'astina più prossima al pavimento. Oltre a fornire un miglioramento contro l'umidità e gli agenti atmosferici, garantisce una migliore schermatura del punto di giunzione.

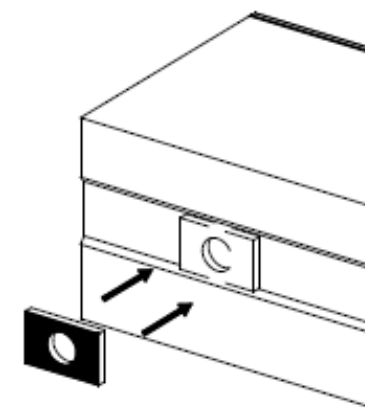
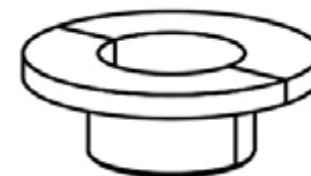

**Obiettivo progettuale:** migliorare l'**affidabilità a lungo termine**, garantendo che gli elementi resistano maggiormente agli agenti atmosferici e alla corrosione senza richiedere manutenzioni complesse. L'obiettivo è fornire un'integrazione di **accorgimenti tecnici per evitare soluzioni improvvisate in cantiere**.

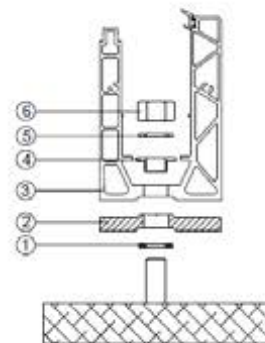
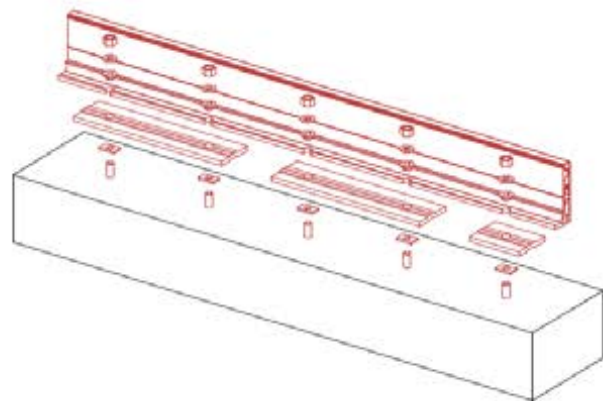
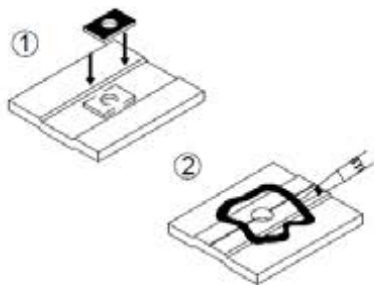

Una volta essiccata la resina, avvicinare il profilo ed iniziare il fissaggio.

Inserire nell'ordine:

- 1) Guarnizione adesiva;
- 2) Spessore deflusso acqua piovana;
- 3) Profilo Ninfa 106;
- 4) Boccola per fissaggio;
- 5) Rondella piana;
- 6) Dado M12.

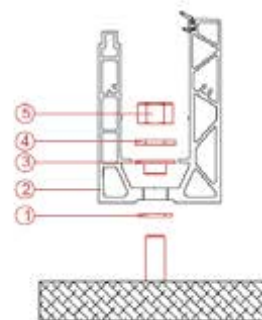
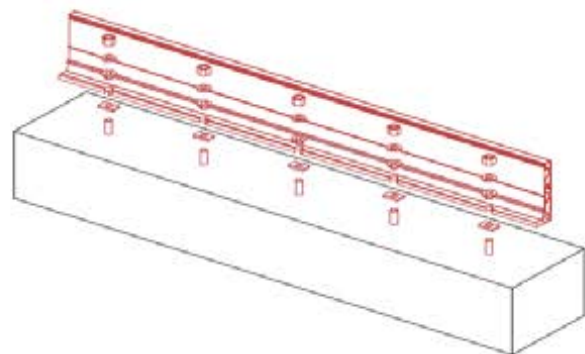
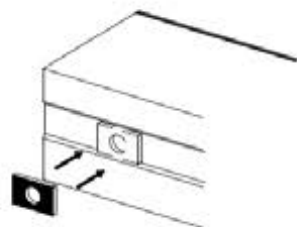

Una volta essiccata la resina, avvicinare il profilo ed iniziare il fissaggio.

Inserire nell'ordine:

- 1) Guarnizione adesiva;
- 2) Profilo Ninfa 106;
- 3) Boccola per fissaggio;
- 4) Rondella piana;
- 5) Dado M12.

**Nuova collezione Corrimano Faraone:**  
design quadrato e rigore tecnico.

---

# CORRIMANO ESSENTIAL

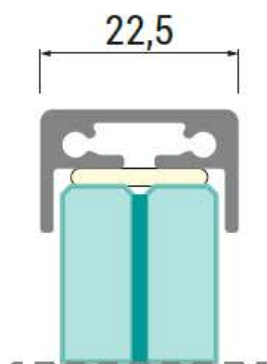
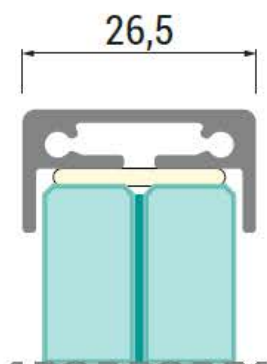

# MINIMAL

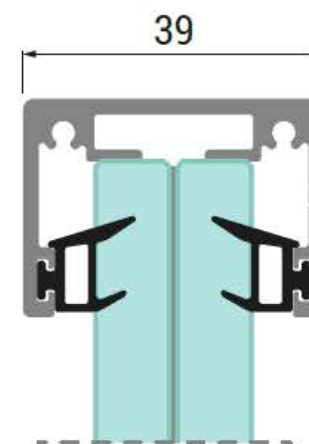
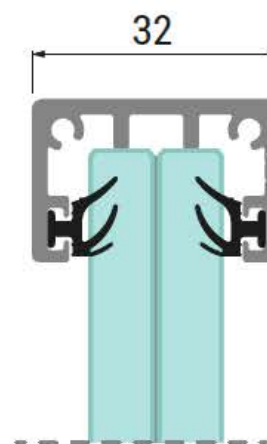

# Innovazioni tecniche e vantaggi

## 25. GIUNZIONI PER CORRIMANO

**Giunzione lineare:** applicare il collante sulla parte interna del giunto e inserire dall'alto.

**Giunzione angolare:** inserire il giunto angolare all'interno del corrimano e avvitare dal basso.

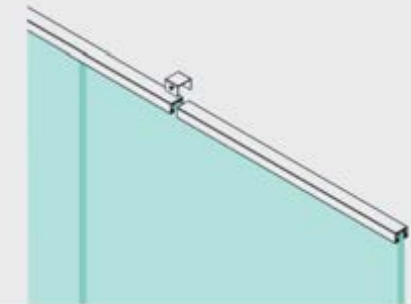
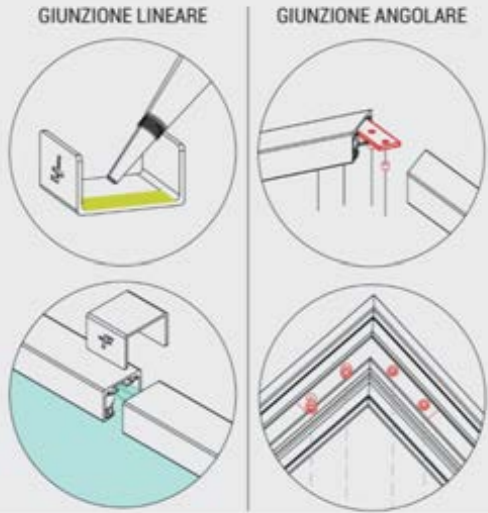

## 26. INSERIRE I TAPPI DI CHIUSURA

Avvitare i tappi laterali di copertura con le viti in dotazione per completare il lavoro.

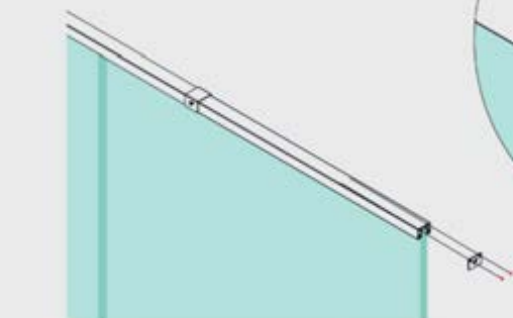
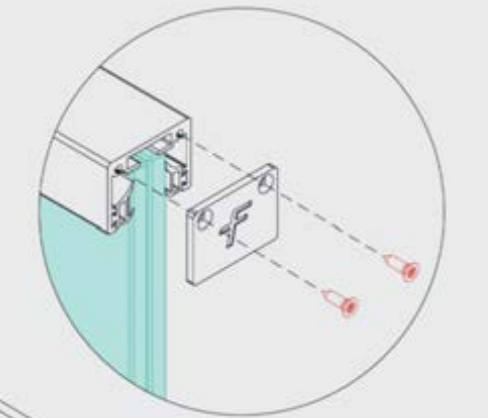

**Giunti integrati:** accessori ideati per coprire i tagli alle giunzioni, **eliminare fessure antiestetiche** dovute anche alle dilatazioni termiche. Mantiene l'allineamento.

**Tappi più affidabili:** fissaggio **meccanico** con viti autofilettanti (non colle) per una tenuta stabile e durature, senza rischi di distacco nel tempo.



**faraone**<sup>®</sup>

PARAPETTI



I PARAPETTI IN VETRO N.1 IN ITALIA

SPETTATORI E GIOCATORI AL CENTRO

**VISIBILITA' E SICUREZZA**

**IN TRIBUNA, CON NINFA 6 STADIO**

Roberto Volpe – CMO | Matteo Paolini – Direttore Tecnico | Gabriele Romagnoli – Ingegnere

**faraone**<sup>®</sup>



soci



ASSOCIAZIONE  
IMPIANTI  
SPORTIVI

faraone.it

**GRAZIE.**

**FARAONE@FARAONE.IT**

ROBERTO VOLPE | MATTEO PAOLINI | GABRIELE ROMAGNOLI | WILLIAM BARNI

---

# WILLIAM BARNI



Cittadella dello Sport  
Sport. Emozioni. Emozioni.

Cittadella dello Sport

Cittadella dello Sport

Cittadella dello Sport  
Sport. Emozioni. Emozioni.

Cittadella dello Sport

Cittadella dello Sport

Cittadella dello Sport

Cittadella dello Sport

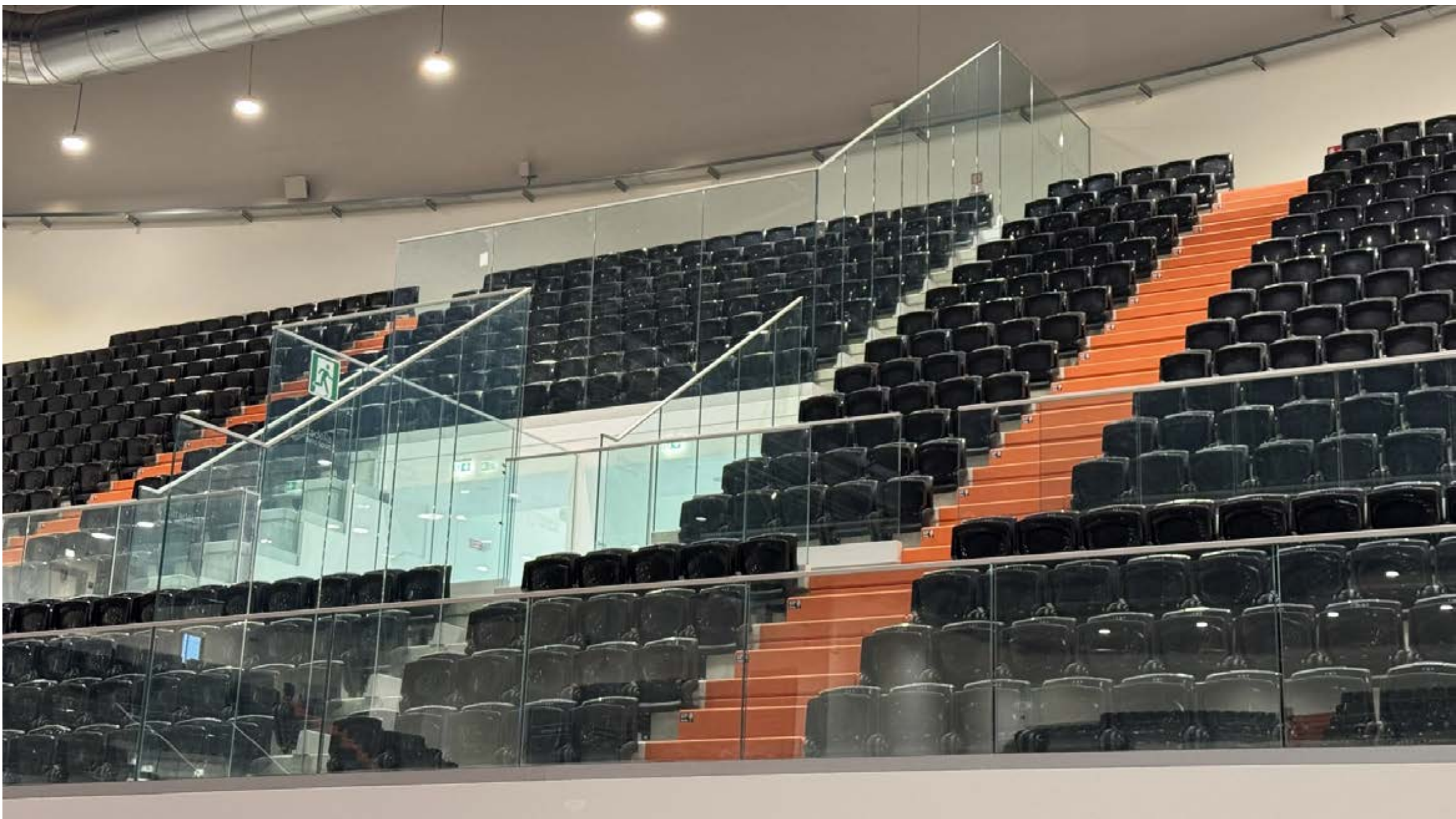

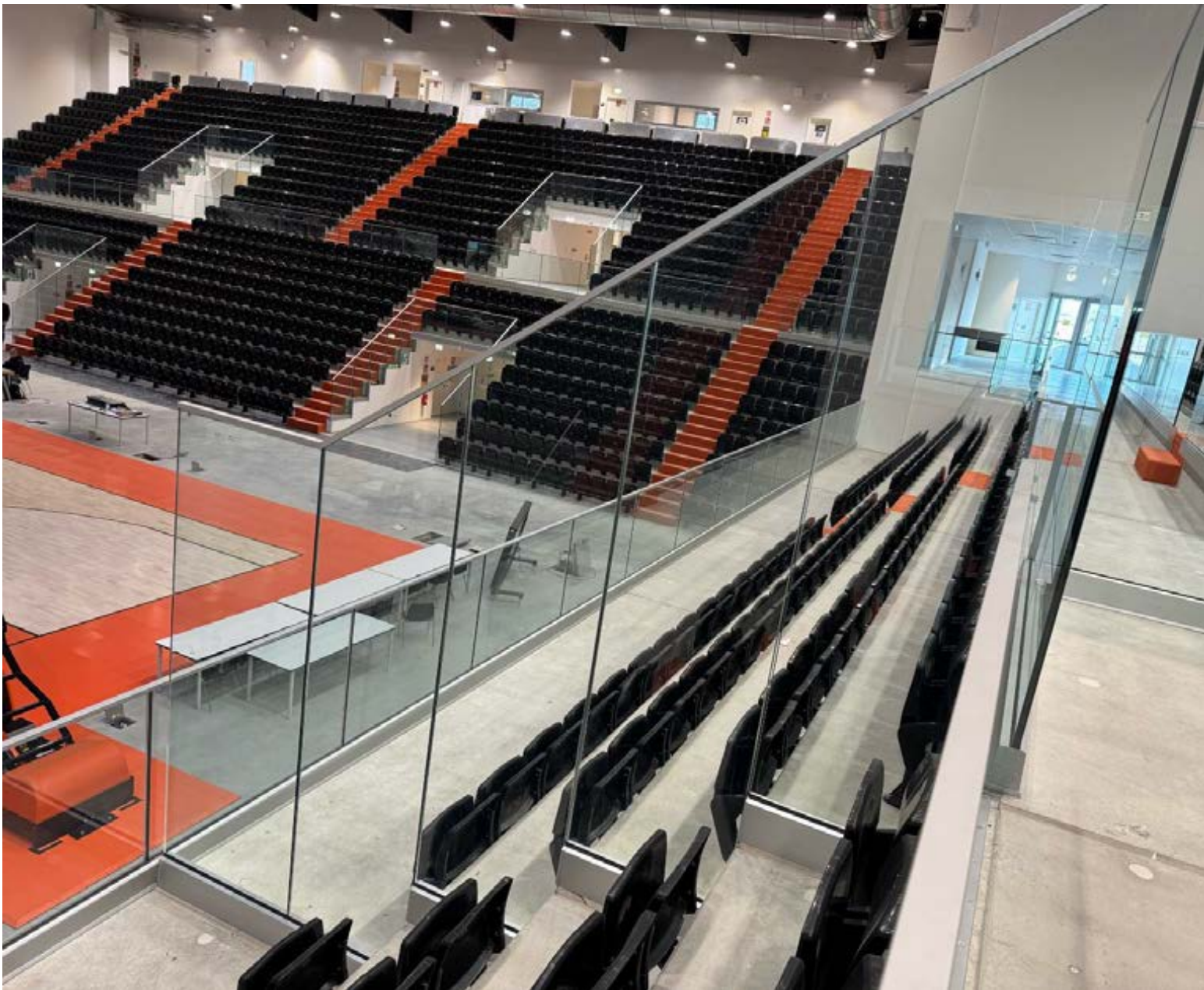

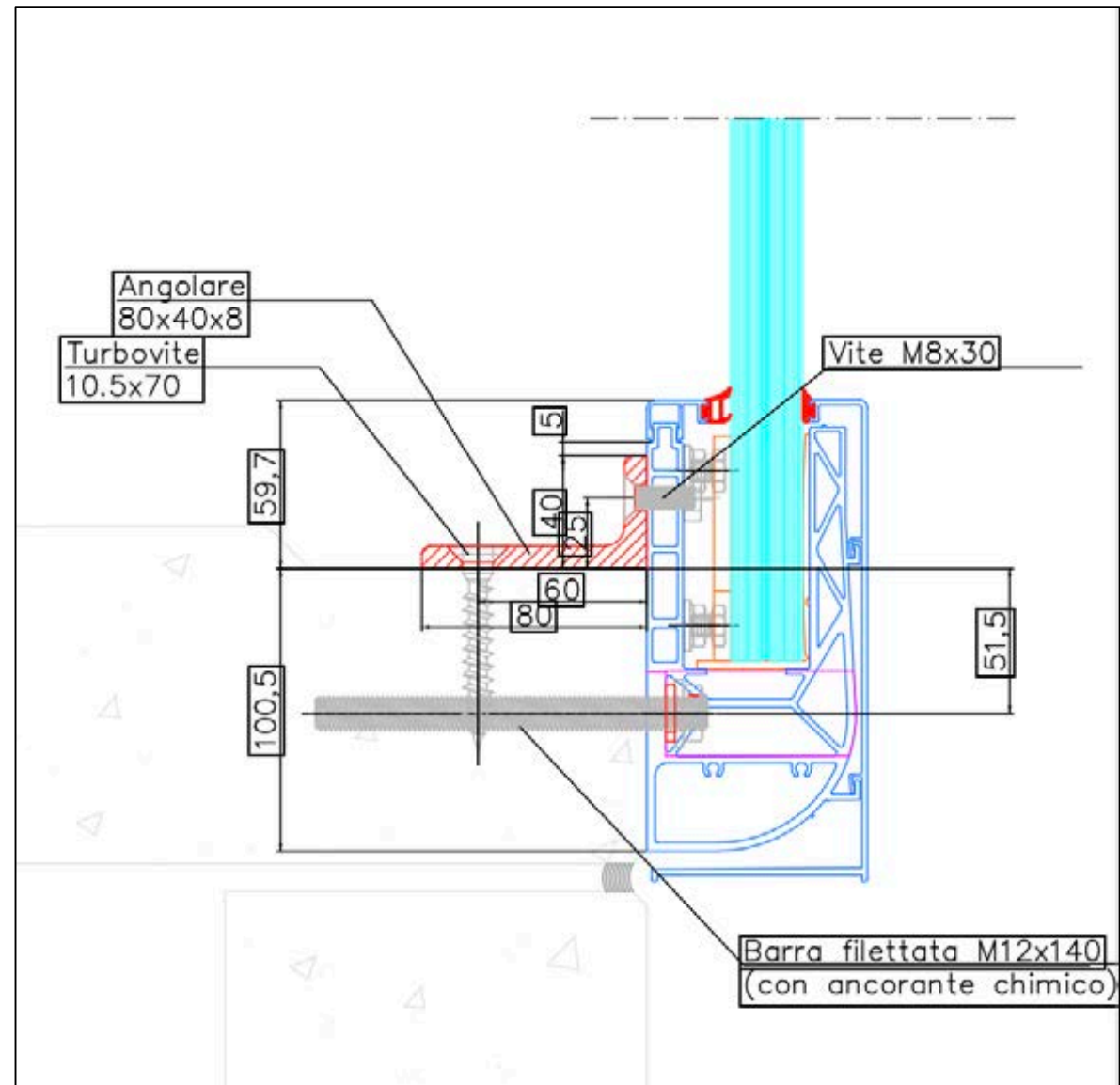

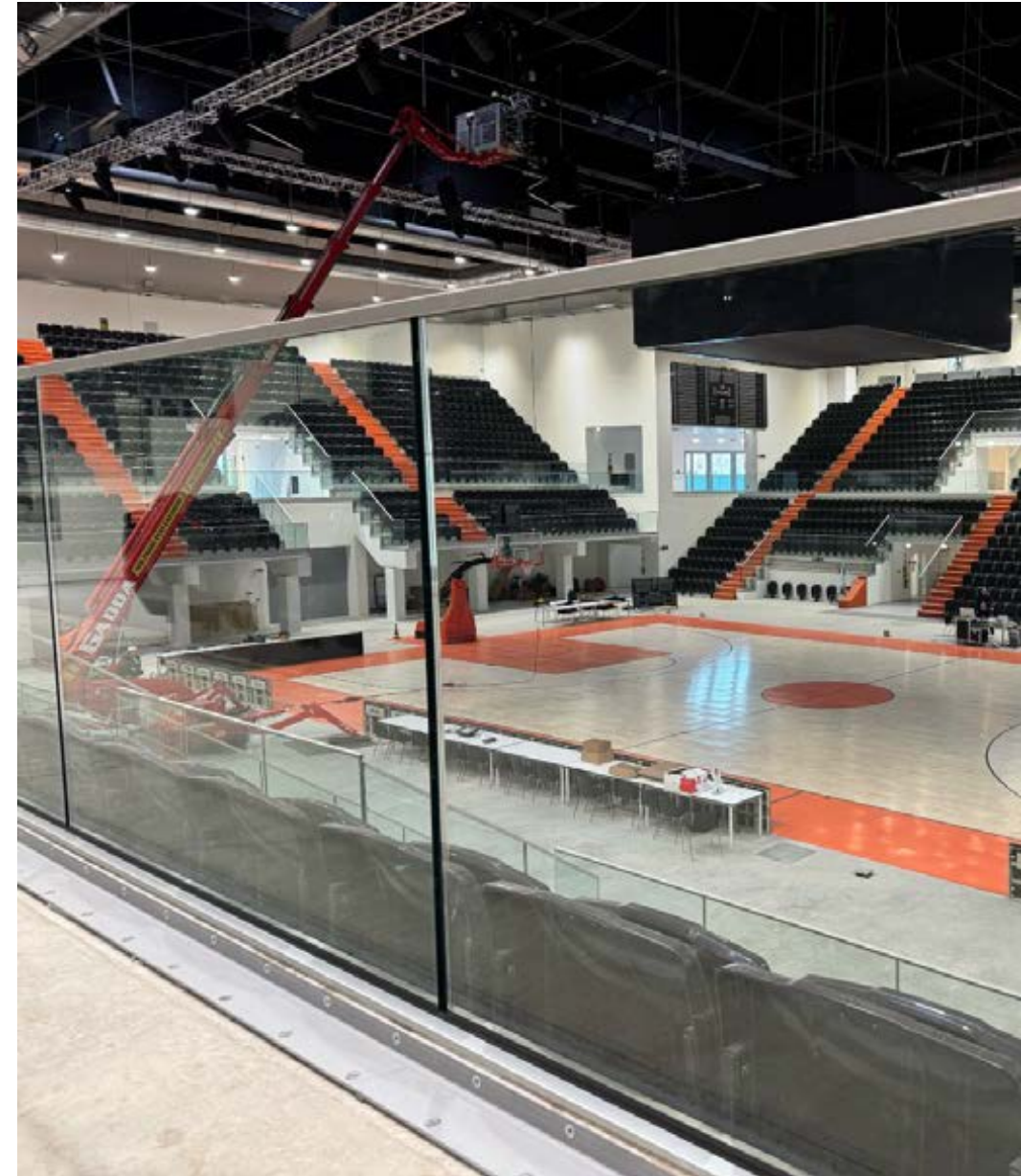
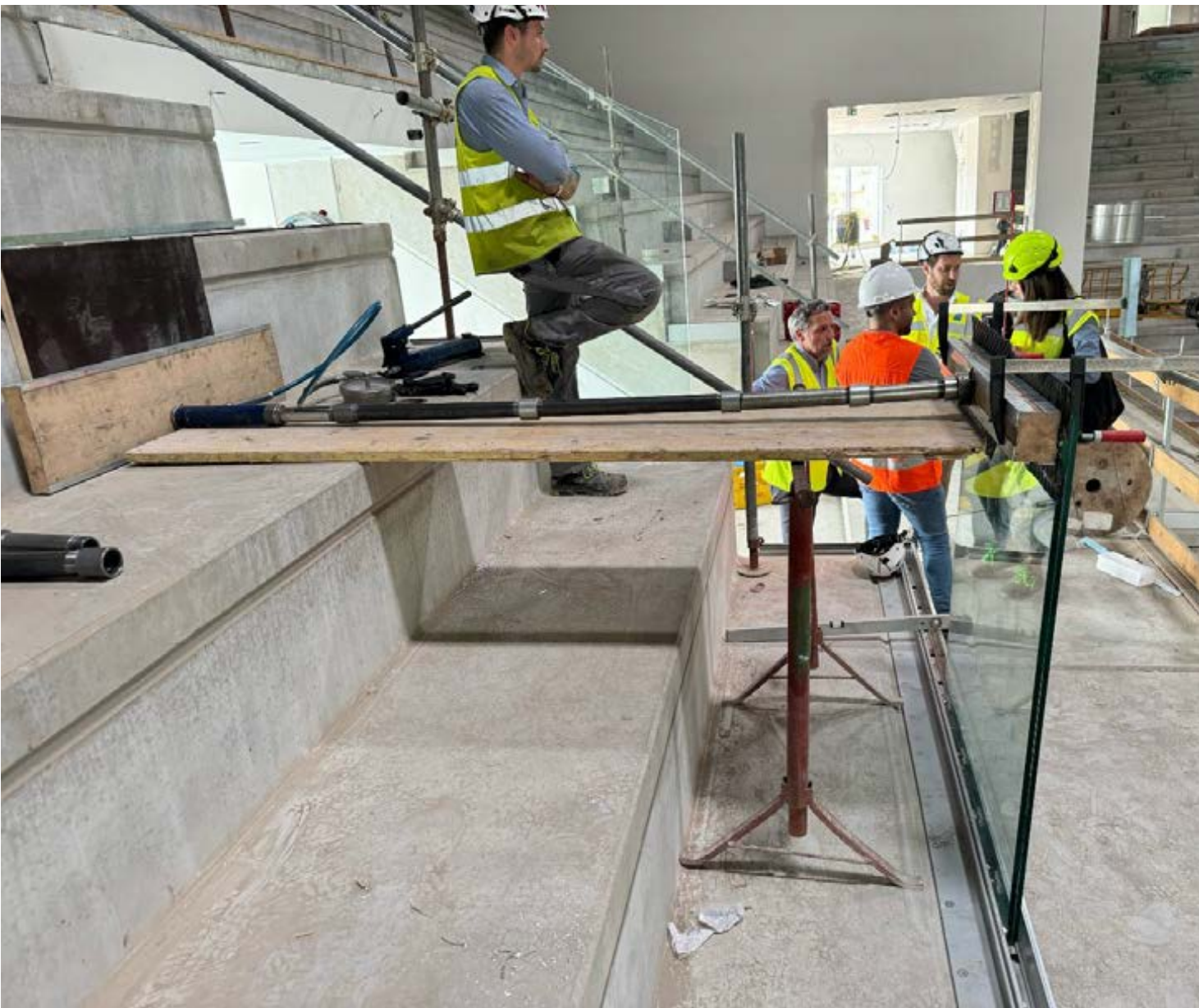



# **BALAUSTRE**

# **BORDO CAMPO**









# **BALAUSTRE SETTORE OSPITI**





# **BALAUSTR DIVISORI DI SETTORE**



## Disegni dettagliati e soluzioni custom:

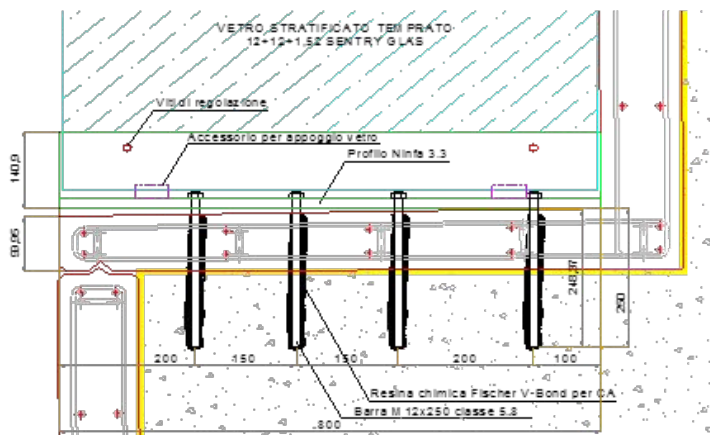
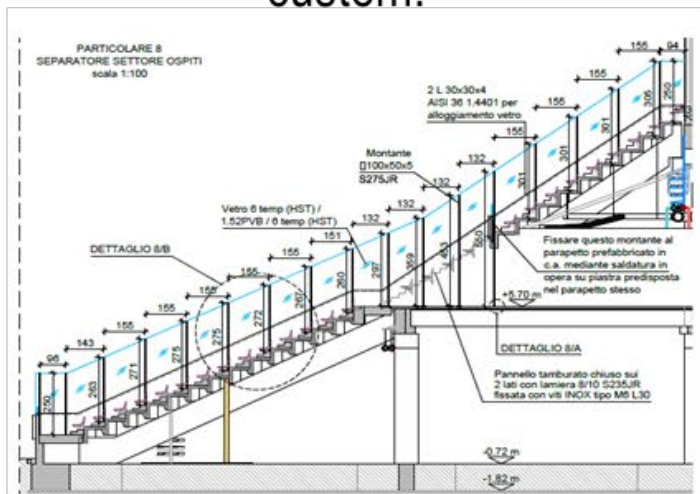

## Prove di carico in cantiere:



## Analisi FEM statiche e dinamiche:

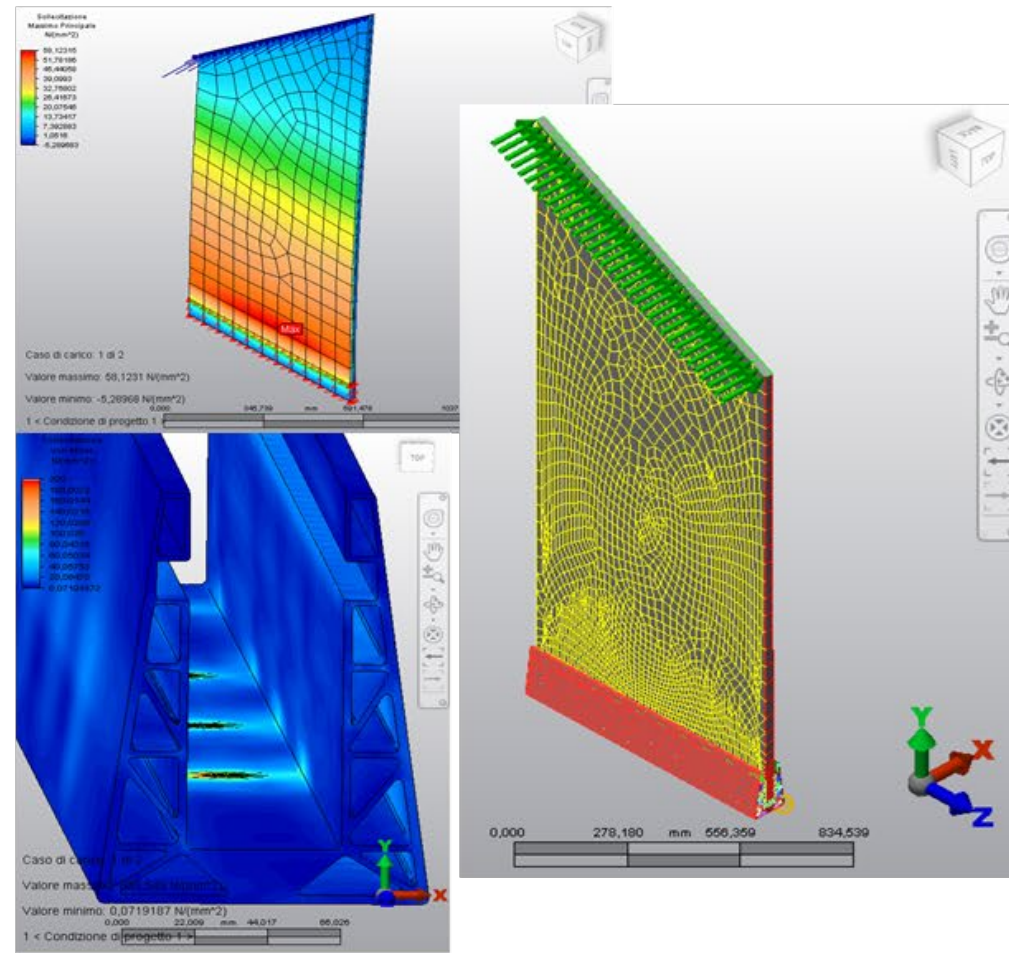









# **COPERTURE PICH VIEW E OSPITALITY**



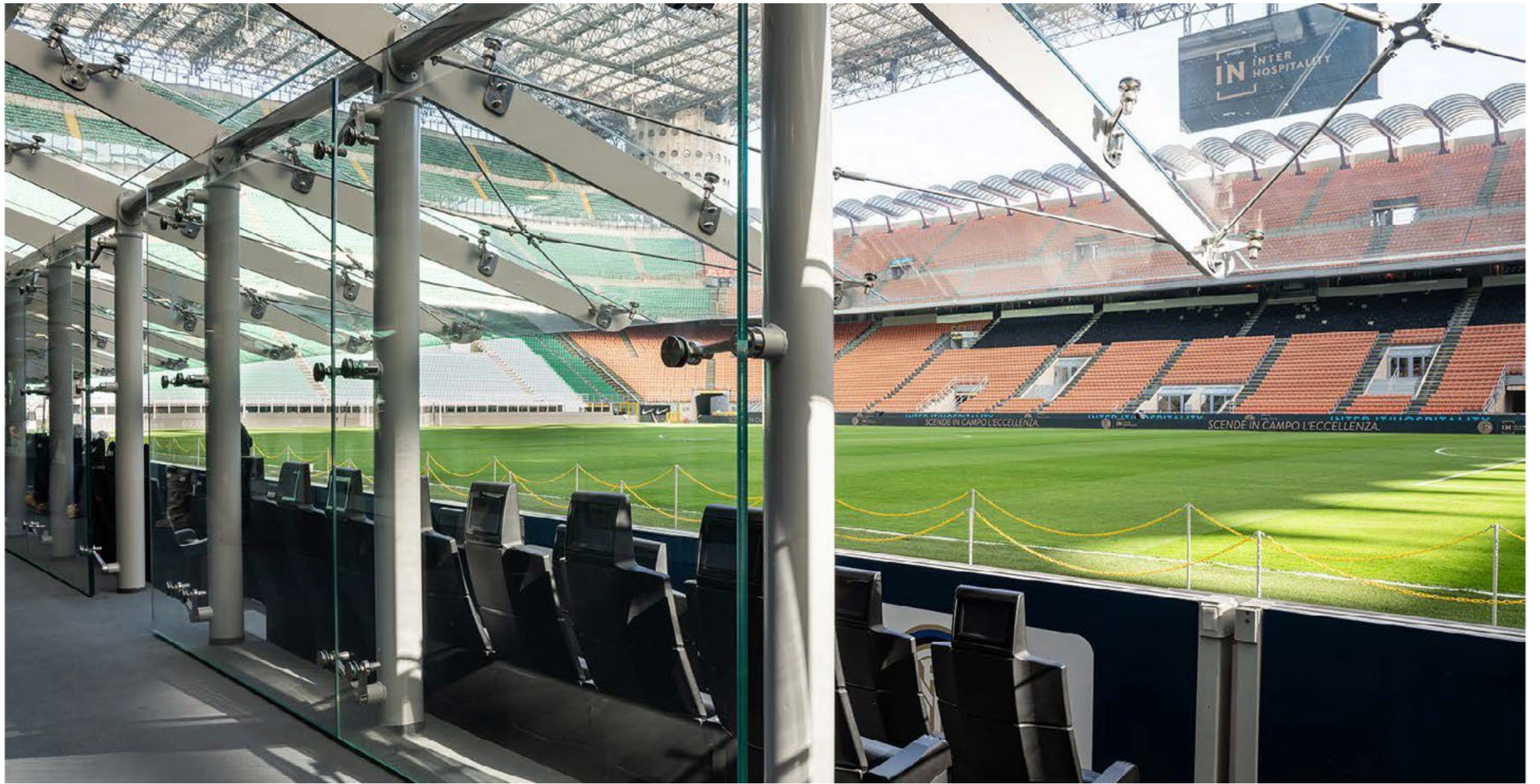

# **BALAUSTRE**

# **SKY BOX**





# CANCELLETTI DI SICUREZZA







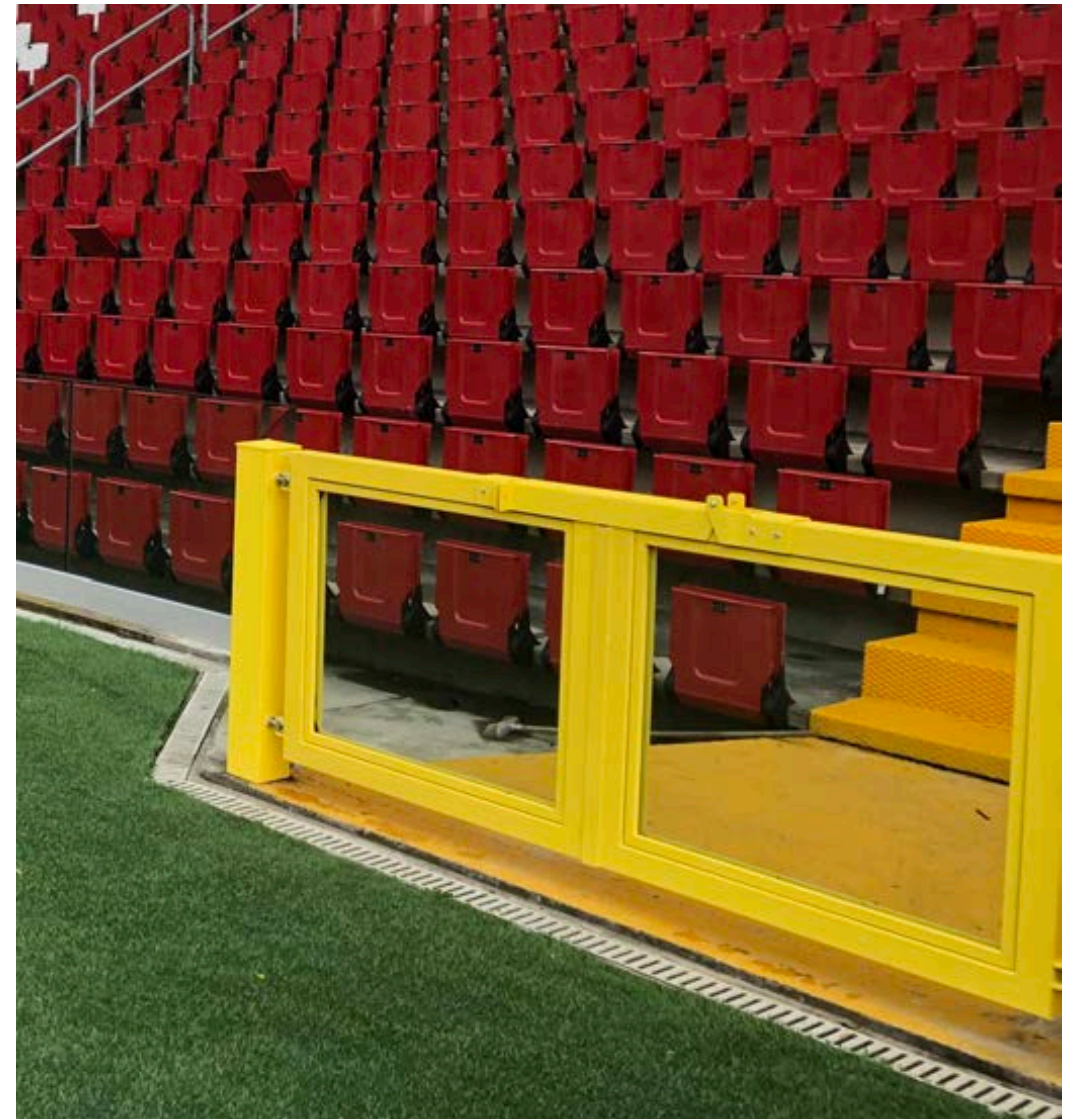



# ILLUMINAZIONE SCENOGRAFICA





# SICUREZZA



**VERSO LO SPETTACOLO:  
IL PERCORSO FARAONE**

# ANALISI CON PROGETTISTA

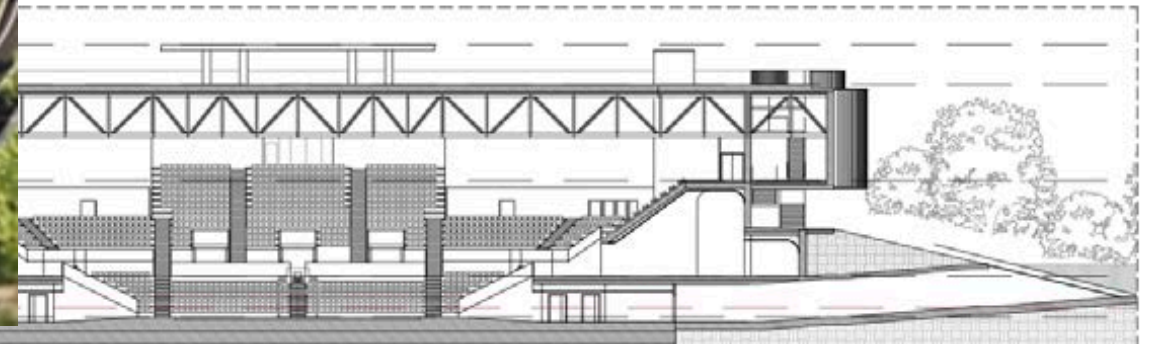
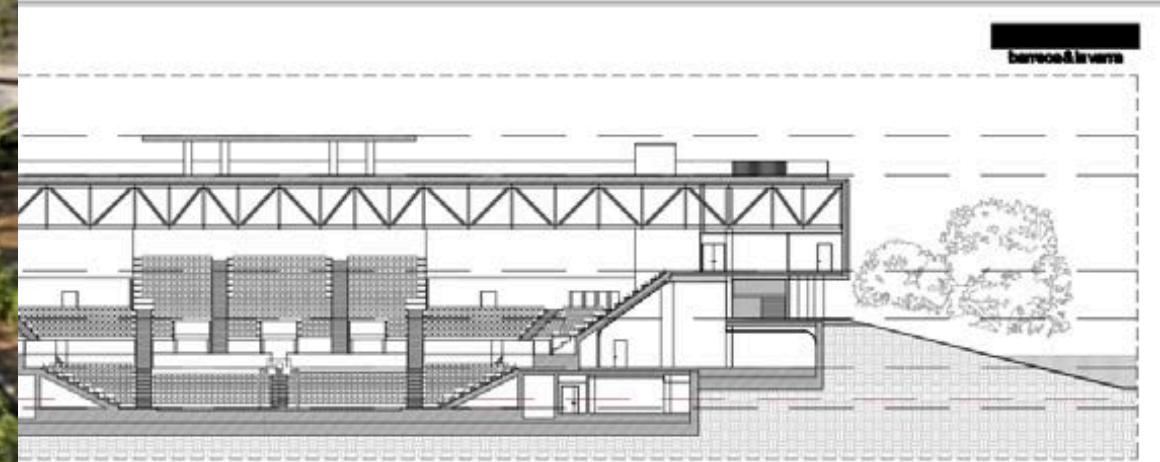

# DISEGNI E CAPITOLATO



Redatto da: William Barni

Milano li, 12 novembre 2020

Spett.le BARRECA E LA VARRA  
Via Tito Vignoli, 9  
20146 Milano  
Att.ne Arch.EliSa Giannini  
Rif. Palazzetto Tortona

## BALAUSTRÉ PALAZZETTO DI TORTONA (AL)

A seguito della richiesta ricevuta, ringraziamo per l'opportunità e siamo lieti risponderVi.

In questa fase preliminare, in mancanza di un progetto esecutivo da esaminare, la presente offerta ha l'obiettivo di determinare un prezzo indicativo per orientarsi sul budget di spesa.

L'eventuale fornitura e messa in opera delle opere sarà realizzata da un ns partner di fiducia. (Faraone Club Expert)

Le voci incluse nella presente quotazione sono:

- Sistema di fissaggio in alluminio, per realizzare la balaustra in vetro Ninfa
- Vetri;
- Installazione;

La fornitura dei profili, dei vetri e la posa

Restano escluse dalla presente offerta e dalla nostra fornitura le seguenti voci:

- Quanto non espressamente citato.

64018 Tortoreto (TE) - Via Po - Tel. 0861784210 Fax 0861781035 - Cod. fiscale P. I.V.A. 00321830671  
Web-site: <http://www.faraone.it>

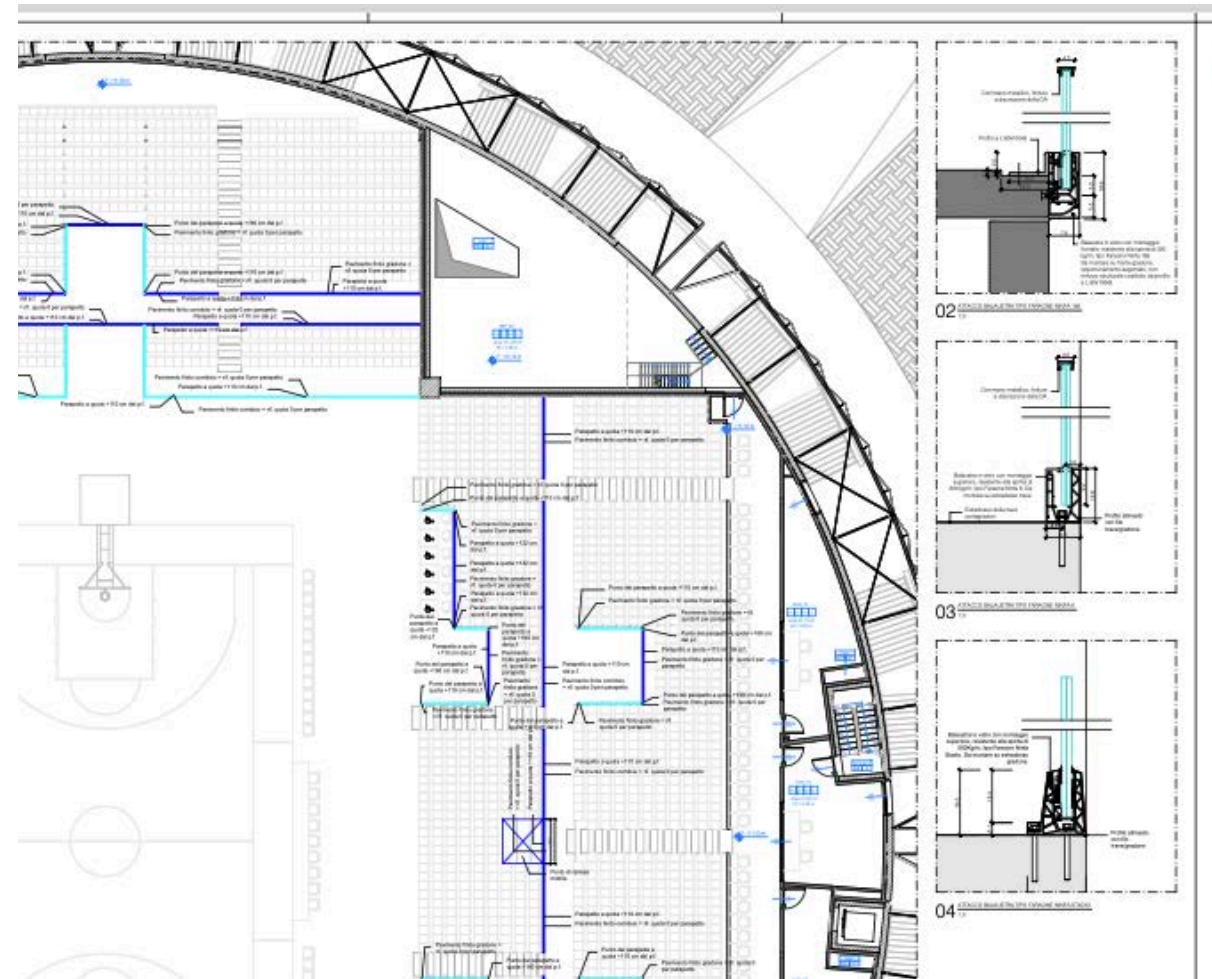

# SOPRALLUOGO CON D.L. E



# PROVE IN CANTIERE



# SUPPORTO DURANTE I LAVORI

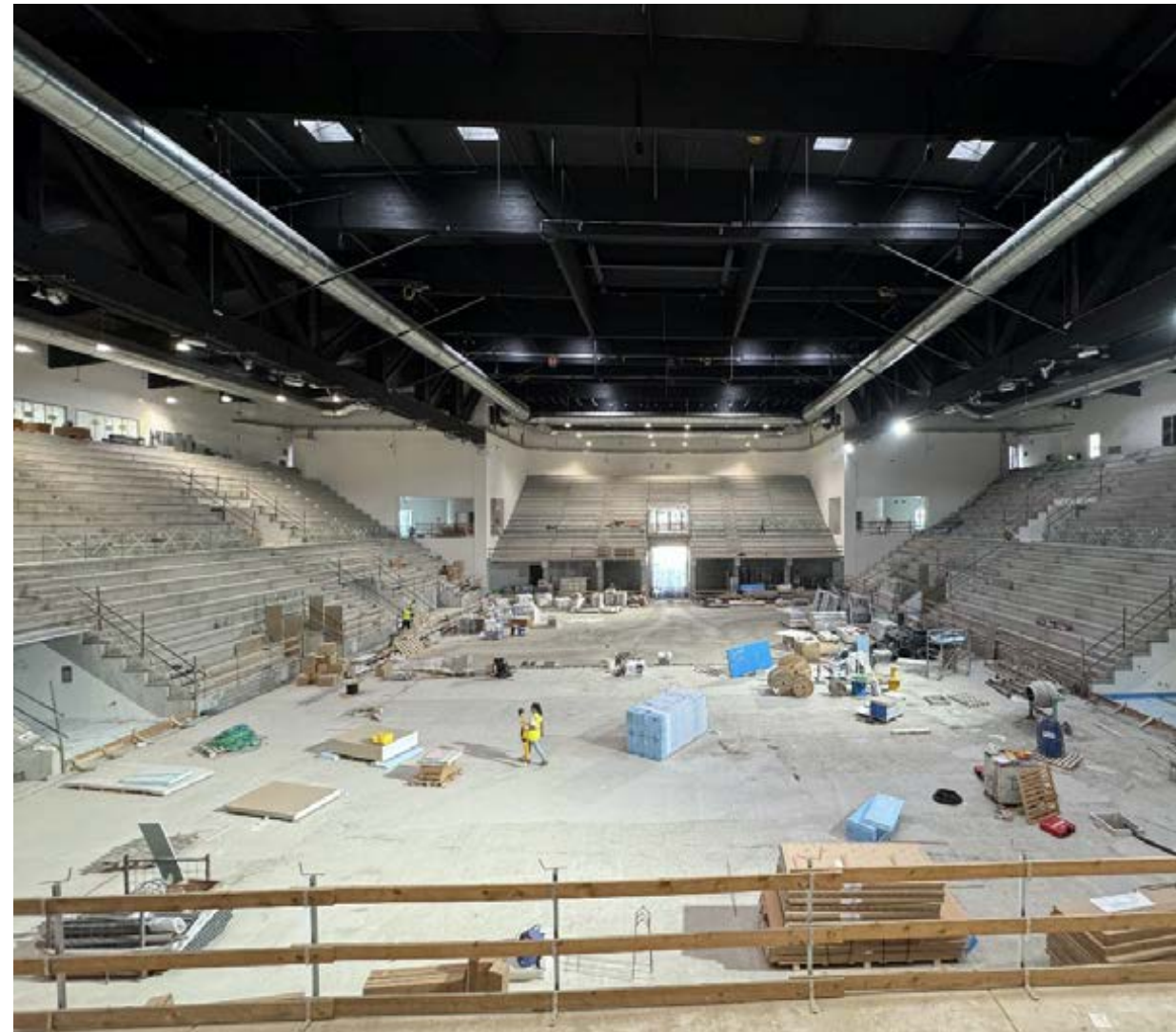

# SOPRALLUOGO FINALE



# PASSERELLA TRASPARENTE

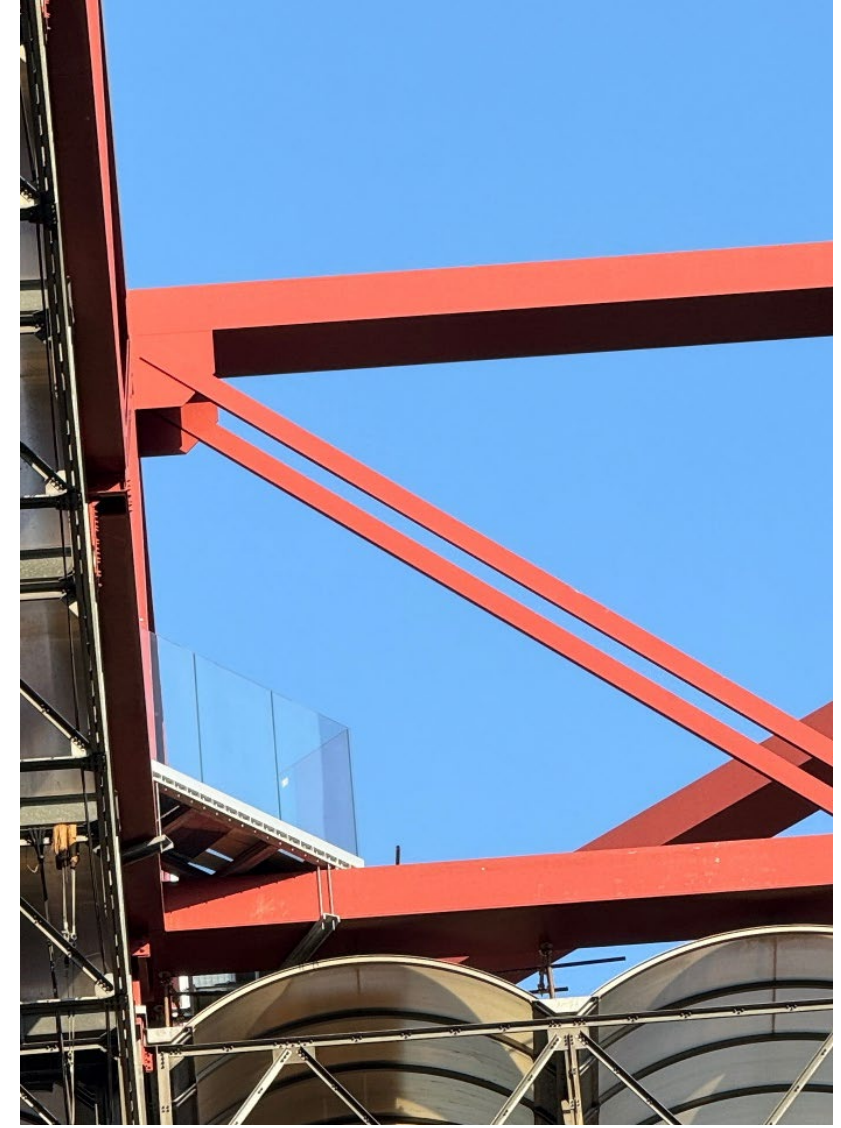
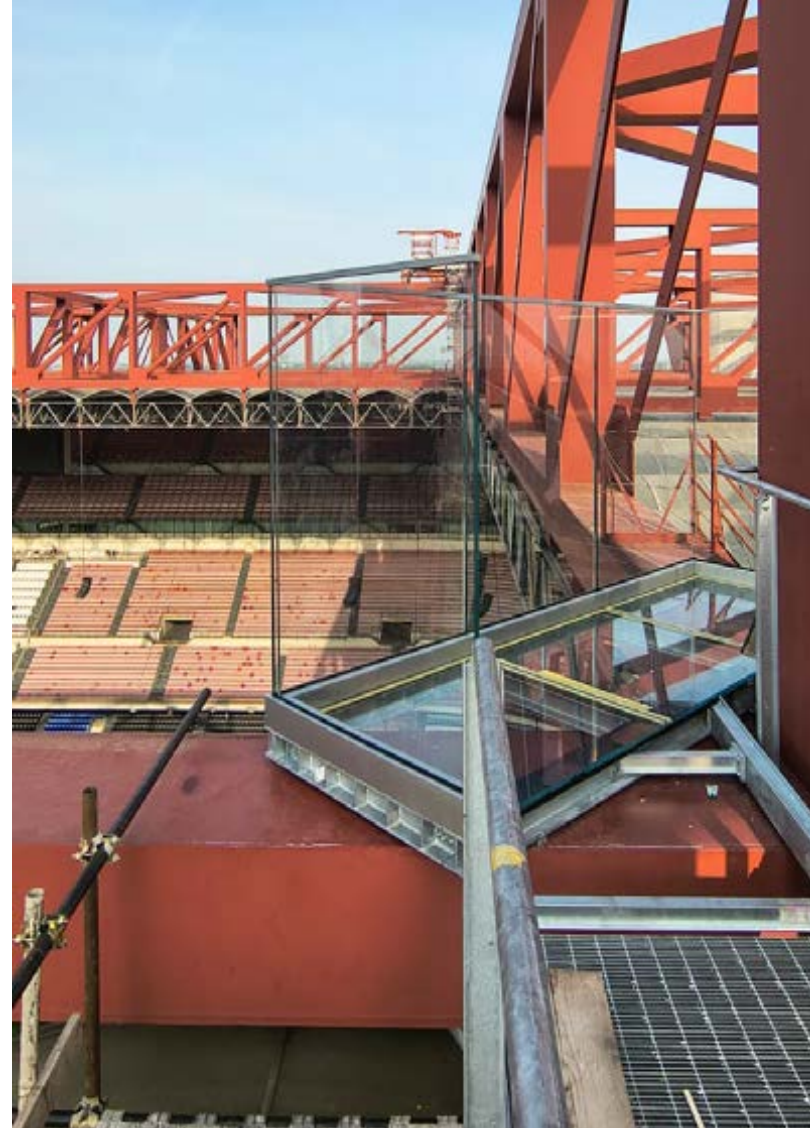

**faraone**<sup>®</sup>

PARAPETTI

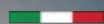

I PARAPETTI IN VETRO N.1 IN ITALIA

SPETTATORI E GIOCATORI AL CENTRO

**VISIBILITA' E SICUREZZA**

**IN TRIBUNA, CON NINFA 6 STADIO**

Roberto Volpe – CMO | Matteo Paolini – Direttore Tecnico | Gabriele Romagnoli – Ingegnere

**faraone**<sup>®</sup>



soci



ASSOCIAZIONE  
IMPIANTI  
SPORTIVI

faraone.it

**GRAZIE.**

**FARAONE@FARAONE.IT**

ROBERTO VOLPE | MATTEO PAOLINI | GABRIELE ROMAGNOLI | WILLIAM BARNI

---

# ROBERTO VOLPE

**DOVE DOBBIAMO USARE  
IL CASCO DA MOTO GP?**

---

PARAPETTI DA SERIE A

# ecco alcune ispirazioni

# SANTAGIULIA – OLIMPIADI MILANO CORTINA 2026

**faraone**<sup>®</sup>



soci



ASSOCIAZIONE  
IMPIANTI  
SPORTIVI

faraone.it



# CAMPO CENTRALE PHILIPPE CHATRIER – ROLAND GARROS - PARIGI

**faraone**<sup>®</sup>



soci



ASSOCIAZIONE  
IMPIANTI  
SPORTIVI

faraone.it



# CAMPO CENTRALE PHILIPPE CHATRIER – ROLAND GARROS - PARIGI



# CAMPO CENTRALE PHILIPPE CHATRIER – ROLAND GARROS - PARIGI

**faraone**<sup>®</sup>



soci



ASSOCIAZIONE  
IMPIANTI  
SPORTIVI

faraone.it

# CAMPO CENTRALE PHILIPPE CHATRIER – ROLAND GARROS - PARIGI



# CAMPO CENTRALE PHILIPPE CHATRIER – ROLAND GARROS - PARIGI

**faraone**<sup>®</sup>



soci



ASSOCIAZIONE  
IMPIANTI  
SPORTIVI

faraone.it



# CAMPO CENTRALE PHILIPPE CHATRIER – ROLAND GARROS - PARIGI

**faraone**<sup>®</sup>



soci



faraone.it



# GEWISS STADIUM - BERGAMO

**faraone**<sup>®</sup>



soci



ASSOCIAZIONE  
IMPIANTI  
SPORTIVI

faraone.it



# GEWISS STADIUM - BERGAMO

**faraone**<sup>®</sup>



soci



ASSOCIAZIONE  
IMPIANTI  
SPORTIVI

faraone.it



**GEWISS STADIUM - BERGAMO**



GEWISS STADIUM - BERGAMO





# GEWISS STADIUM - BERGAMO

**faraone**<sup>®</sup>



soci



ASSOCIAZIONE  
IMPIANTI  
SPORTIVI

faraone.it



# GEWISS STADIUM - BERGAMO

**faraone**<sup>®</sup>



soci



ASSOCIAZIONE  
IMPIANTI  
SPORTIVI

faraone.it

Industry

Hos

# GEWISS



# WOW

## GEWISS STADIUM - BERGAMO

**faraone**<sup>®</sup>



soci



ASSOCIAZIONE  
IMPIANTI  
SPORTIVI

faraone.it



# GEWISS STADIUM - BERGAMO

**faraone**<sup>®</sup>



soci



ASSOCIAZIONE  
IMPIANTI  
SPORTIVI

faraone.it



## CENTRO NOTATORIO - FANO

**faraone**<sup>®</sup>



soci



ASSOCIAZIONE  
IMPIANTI  
SPORTIVI

faraone.it



# PALA BARTON - PERUGIA

**faraone**<sup>®</sup>



soci



ASSOCIAZIONE  
IMPIANTI  
SPORTIVI

faraone.it



# PALA BARTON - PERUGIA

**faraone**<sup>®</sup>



soci



ASSOCIAZIONE  
IMPIANTI  
SPORTIVI

faraone.it



# STADIO NEREO ROCCO - TRIESTE

**faraone**<sup>®</sup>



soci



faraone.it



# STADIO LUIGI FERRARIS - GENOVA

**faraone**<sup>®</sup>



soci



ASSOCIAZIONE  
IMPIANTI  
SPORTIVI

faraone.it



# PISCINA FELICE SCANDONE - NAPOLI

**faraone**<sup>®</sup>



soci



ASSOCIAZIONE  
IMPIANTI  
SPORTIVI

faraone.it



# JUVENTUS TRAINING CENTER «CONTINASSA» - TORINO



AUTODROMO NAZIONALE - MONZA



# U-POWER STADIUM - MONZA

**faraone**<sup>®</sup>



soci



faraone.it



# TRAINING CENTER SPEZIA CALCIO – LA SPEZIA



STADIO PENZO - VENEZIA



# PALAZZETTO DI MANIAGO

**faraone**<sup>®</sup>



soci



ASSOCIAZIONE  
IMPIANTI  
SPORTIVI

faraone.it



  
Stadium

# ALBINOLEFFE STADIUM

**faraone**<sup>®</sup>



soci



faraone.it



# STADIO DI FERRARA

**faraone**<sup>®</sup>



soci



ASSOCIAZIONE  
IMPIANTI  
SPORTIVI

faraone.it



MUGELLO

**faraone**<sup>®</sup>



soci



ASSOCIAZIONE  
IMPIANTI  
SPORTIVI

faraone.it



**faraone**<sup>®</sup>



soci



faraone.it



Cittadella dello Sport  
Sport. Eventi. Emozioni.

Castellana Grotte

Cittadella dello Sport

Cittadella dello Sport  
Sport. Eventi. Emozioni.

**faraone**<sup>®</sup>



soci



ASSOCIAZIONE  
IMPIANTI  
SPORTIVI

faraone.it

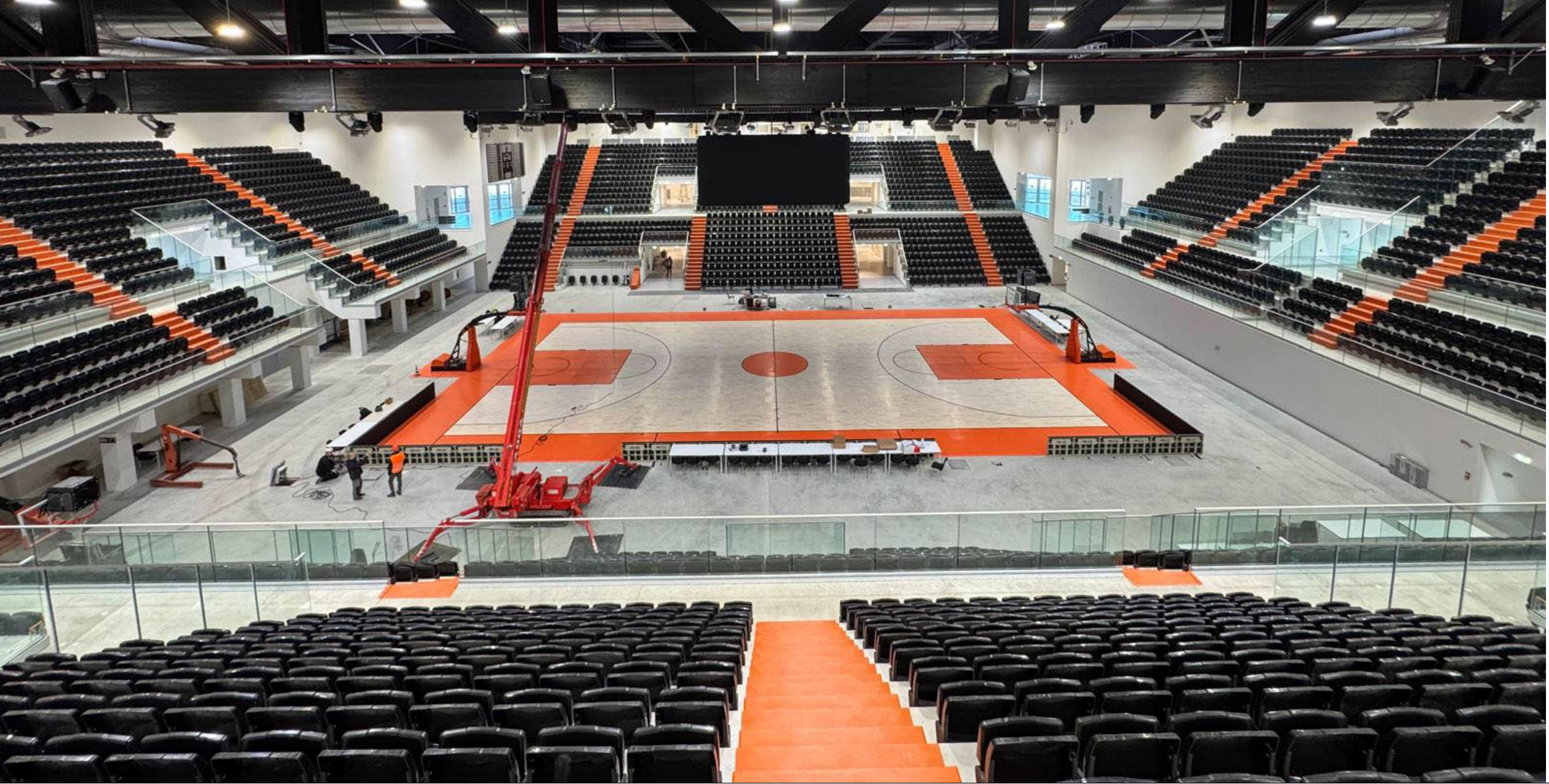



**faraone**<sup>®</sup>



soci



ASSOCIAZIONE  
IMPIANTI  
SPORTIVI

faraone.it

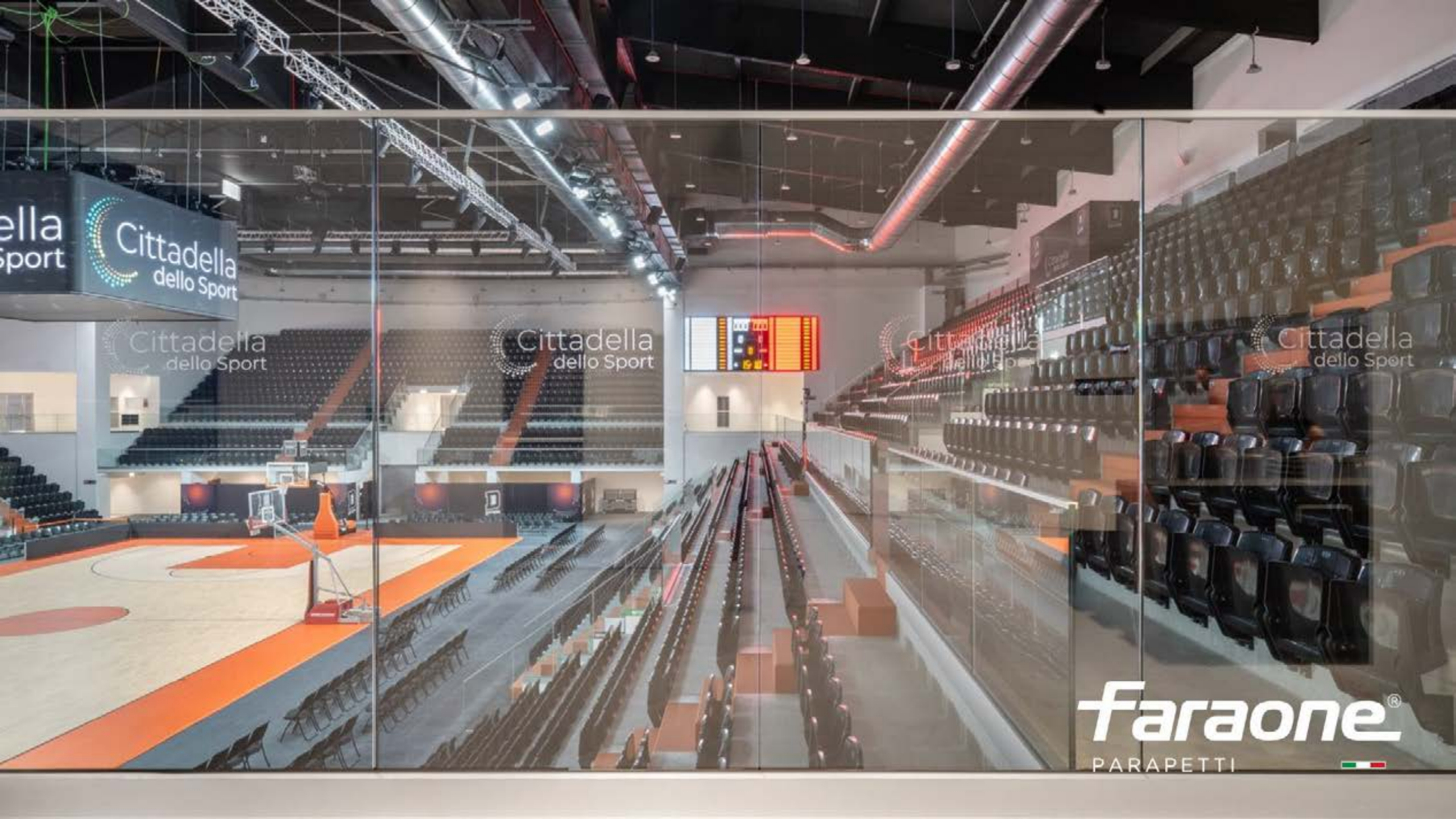

ella  
Sport

Cittadella  
dello Sport

Cittadella  
dello Sport

Cittadella  
dello Sport

Cittadella  
dello Sport

Cittadella  
dello Sport

**faraone**<sup>®</sup>

PARAPETTI

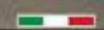

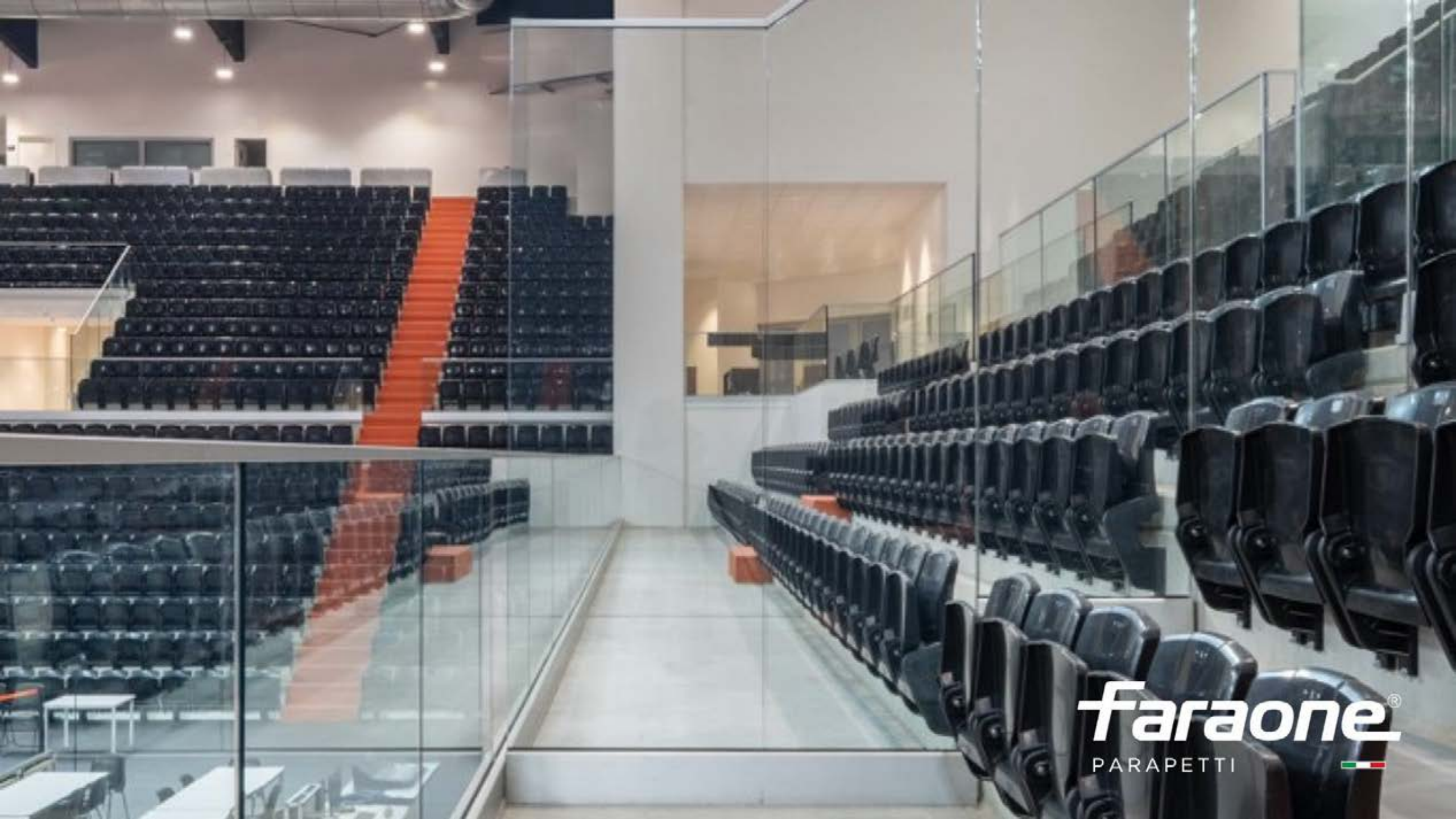

**Faraone**<sup>®</sup>  
PARAPETTI 

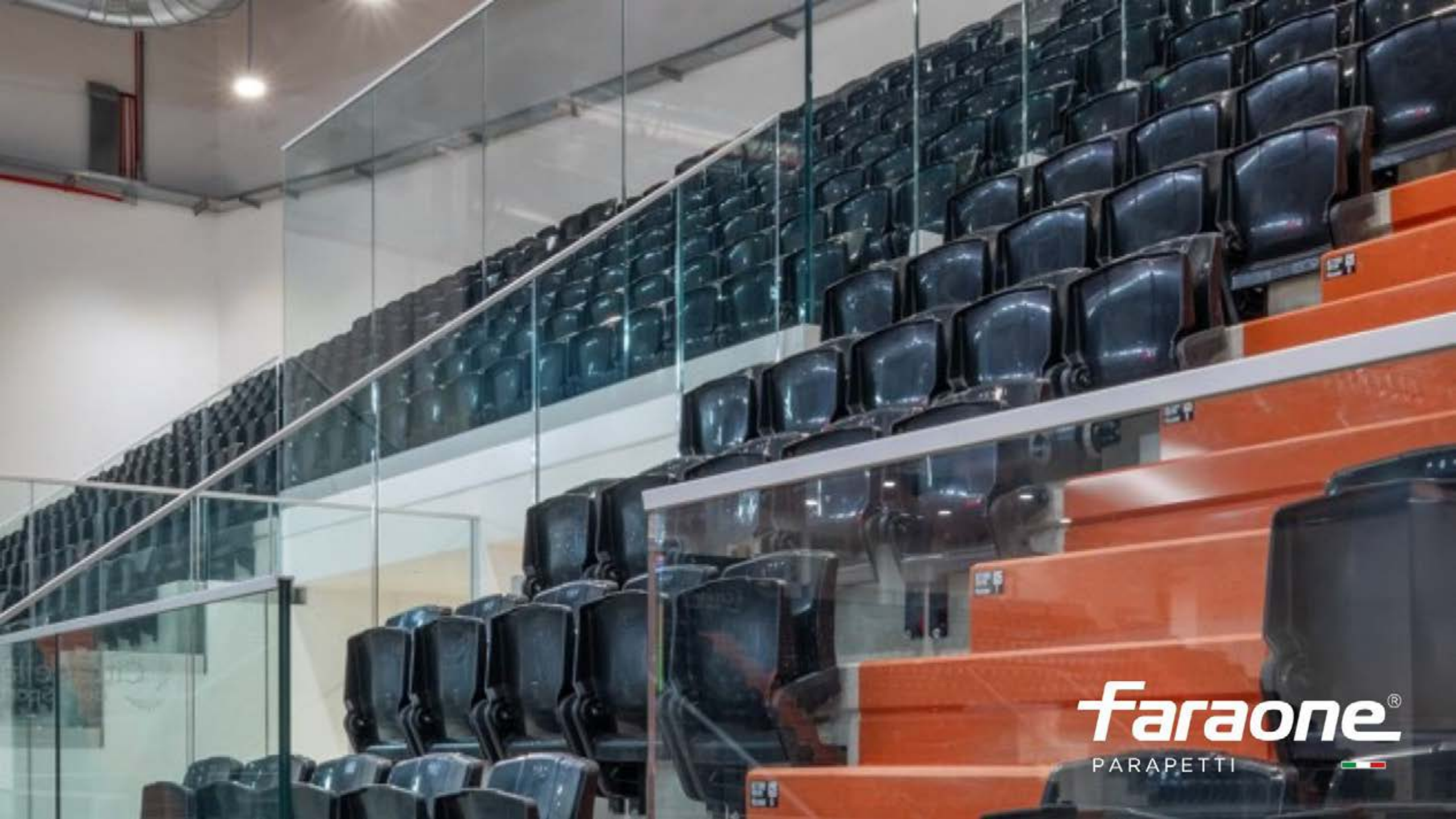

***Faraone***<sup>®</sup>  
PARAPETTI 

DISPONIBILE

IN PDF

[SCARICA QUI](#)

Storyteller #10  
STORIE DI PROGETTI D'ECCELLENZA

# Derthona

*Parapetti in vetro Faraone per la Cittadella dello Sport "Marcellino e Pietro Gavio"*  
General Contractor: CODELFA S.p.A.



**faraone** | [faraone.it](http://faraone.it) | [barrecaelavarra.it](http://barrecaelavarra.it) | **barreca & la varra**

DISPONIBILE

IN PDF

[SCARICA QUI](#)

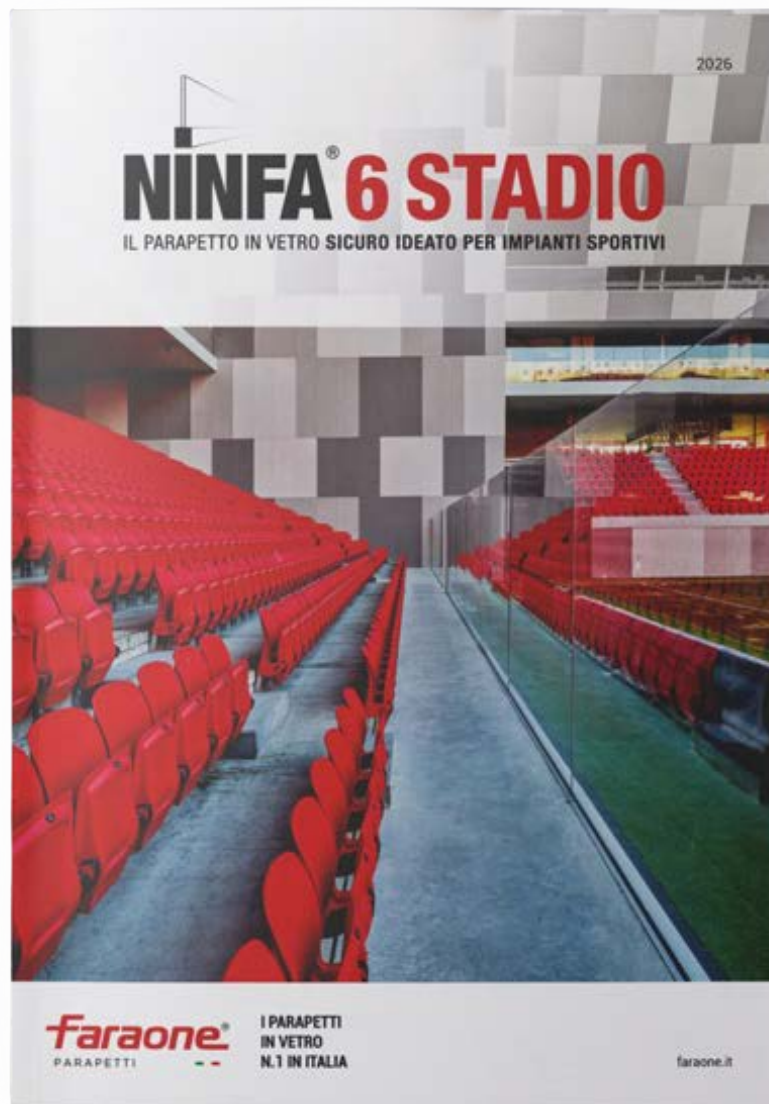

## IL SUPPORTO DI FARAONE

- **Dialogo aperto e supporto tecnico per studi, contract, professionisti del settore**
- **Schede, capitolati, DWG, BIM, supporto normativo**
- **Consulenza in cantiere**
- **Supporto per gare pubbliche**



# LE NOSTRE PUBBLICAZIONI

## MANUALI:

- Manuale del parapetto in vetro



- Manuale degli impianti sportivi



## GUIDE

- Guida alla progettazione dei parapetti in vetro



## BOOK:

- Libro Architetture trasparenti





**RICHIESTO DA  
+ 8.000 PROFESSIONISTI**

**RICHIEDILO SU FARAONE.IT**



**RICHIESTO DA  
+ 17.000  
PROFESSIONISTI**

**RICHIEDILO SU FARAONE.IT**



# RICHIESTA DA + 9.000 PROFESSIONISTI

**RICHIEDILO SU FARAONE.IT**

# METTI IN SICUREZZA LE TRIBUNE. FALLO ADESSO, CON UNA SOLUZIONE CERTIFICATA

## COSA FARE ORA?

→ Attendi l'email di followup

→ Prenota un confronto con i nostri esperti sul campo  
(Analisi > Disegni > Sopralluogo > Prove > Supporto)



# Usereste un casco da bici in MotoGP?

È pur sempre un casco.

**GRAZIE.**

**FARAONE@FARAONE.IT**

ROBERTO VOLPE | MATTEO PAOLINI | GABRIELE ROMAGNOLI | WILLIAM BARNI

---

**faraone**<sup>®</sup>

PARAPETTI

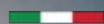

I PARAPETTI IN VETRO N.1 IN ITALIA

SPETTATORI E GIOCATORI AL CENTRO

**VISIBILITA' E SICUREZZA**

**IN TRIBUNA, CON NINFA 6 STADIO**

Roberto Volpe – CMO | Matteo Paolini – Direttore Tecnico | Gabriele Romagnoli – Ingegnere

**faraone**<sup>®</sup>



soci



ASSOCIAZIONE  
IMPIANTI  
SPORTIVI

faraone.it